



# Installation / User Manual

## APsystems ECU-C Energy communication unit with advanced functions

Rev 1.5







© All Rights Reserved

# Table of Contents

<b>Important Safety Instructions</b> .....	<b>2</b>
<b>1.Introduction</b> .....	<b>3</b>
<b>2.Interface Explanation</b> .....	<b>4</b>
2.1 Interface Layout.....	4
2.2 AC Input Port.....	4
2.3 DC Input Port.....	4
2.4 RJ45 Ethernet Network Port.....	5
2.5 RJ45 Signal (Only for Australia) .....	5
2.6 USB Interface.....	5
2.7 Reset.....	5
2.8 LED.....	5
<b>3.Hardware Installation</b> .....	<b>6</b>
3.1 Preparation.....	6
3.2 Selecting an Installation Location for the ECU-C.....	6
3.3 Cable Connections.....	8
3.4 RJ45 Signal connection.....	8
3.5 Internet Connection.....	8
3.6 Current transformer interface.....	10
3.7 Contactor connection.....	11
<b>4.Basic Operation</b> .....	<b>12</b>
4.1 Restore the factory set operation.....	12
<b>5.Local Network Interface</b> .....	<b>13</b>
5.1 Connecting to the ECU-C via the Local Wireless.....	13
5.2 Home Screen.....	13
5.3 Real-time Data Screen.....	15
<b>6.Remote ECU-C Management (EMA)</b> .....	<b>25</b>
6.1 ECU-C Configuration/ECU-C Status Page.....	26
6.2 Setting the ECU-C Time Zone.....	27
6.3 Managing Inverter IDs and Updating the Inverter ID List.....	27
<b>7.Technical Data</b> .....	<b>29</b>

# Important Safety Instructions

Symbols replace words on the equipment, on a display, or in manuals

	Trademark.
	Caution, risk of electric shock.
	Equipment protected throughout by double insulation or reinforced insulation
	CE mark is attached to the solar inverter to verify that the unit follows the provisions of the European Low Voltage and EMC Directives.
Qualified personnel	Person adequately advised or supervised by an electrically skilled person to enable him or her to perceive risks and to avoid hazards which electricity can create. For the purpose of the safety information of this manual, a "qualified person" is someone who is familiar with requirements for safety, refrigeration system and EMC and is authorized to energize, ground, and tag equipment, systems, and circuits in accordance with established safety procedures. The inverter and endues system may only be commissioned and operated by qualified personnel.

# 1.Introduction

The APsystems Energy Communication Unit (ECU-C) is the information gateway for our microinverters. The unit collects module performance data from each individual microinverter and transfers this information to an Internet database in real time. Through the APsystems Energy Monitoring and Analysis software, the ECU-C gives you precise analysis of each microinverter and module in your solar installation from any web-connected device. The ECU-C's integrated http webserver offers the simplest and most flexible network integration of any data logger on the market. The user-friendly browser-based interface lets you access your solar array in seconds.

## Features

- Collects individual module and microinverter statistics
- Remote communication
- Requires no additional wiring
- Applicable commercial system

The APsystems Microinverter is used in utility-interactive grid-tied applications, and is made up of three key elements:

- APsystems Microinverter
- APsystems Energy Communication Unit (ECU-C)
- APsystems Energy Monitoring and Analysis (EMA) web-based monitoring and analysis system

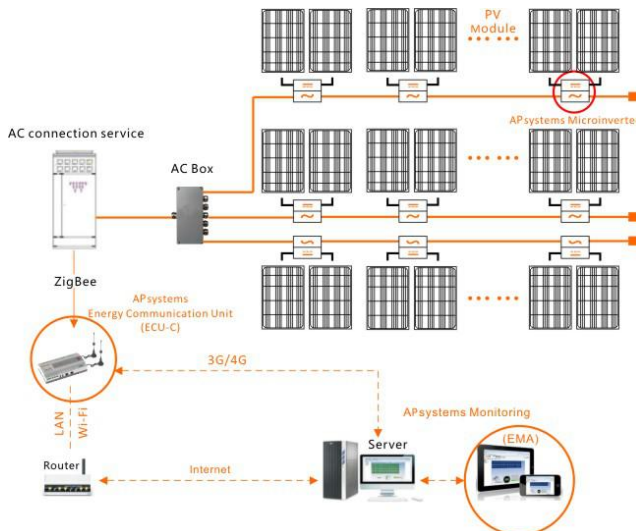

Figure 1

## 2.Interface Explanation

### 2.1 Interface Layout

The ECU-C interface includes, (figure 2)from left to right, are AC Input, Production CT、Consumption CT、Relay Output、RelayFeedback Input、Reset.

(figure 3)from left to right, arePort、DC、RS232、RS485、USB1、USB2、RJ45、Internet、RJ45 Signal.

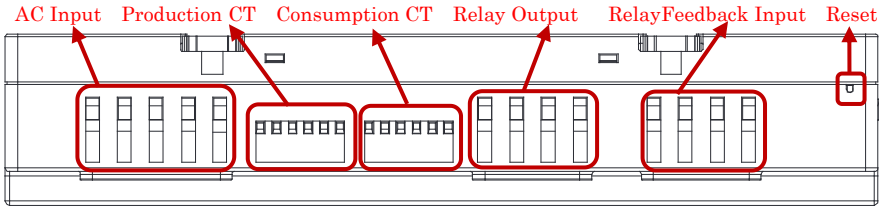

Figure 2

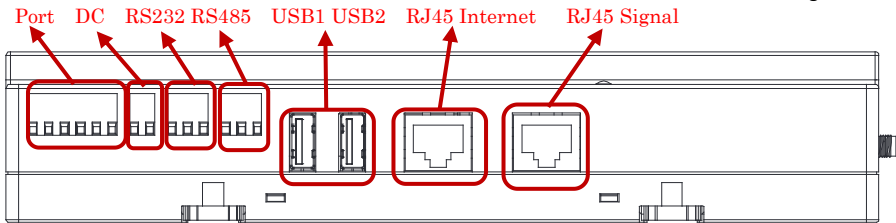

Figure 3

### 2.2 AC Input Port

The AC Input port connects power through the power line.If only single-phase power is needed, the L1 must be connected.

	L1	L2	L3	N	PE
Three Phase	√	√	√	√	√
Single Phase	√	×	×	√	√



#### NOTICE

The AC input power should be assembled with disconnector(e.g. when the current is bigger than 1A, the disconnector should be operated).

### 2.3 DC Input Port

The DC Input port connects power through the 16V DC power line.

## 2.Interface Explanation

### 2.4 RJ45 Ethernet Network Port

The ECU-C allows the user to communicate with the EMA, or log in to the ECU-C's local page in the absence of the wired LAN and WLAN, to set up the system and view the system data via Ethernet network port.

#### NOTICE

Ethernet cable connection is recommended for stable communication.

### 2.5 RJ45 Signal (Only for Australia)

The RJ45 Signal is designed for DRM0/5/6/7/8, it should be connected by RJ45 connector in the package otherwise the inverters will not work.

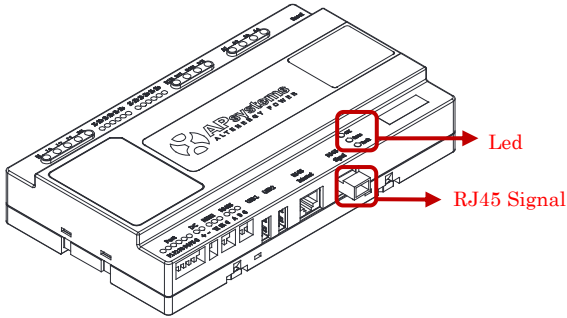

Figure 4

### 2.6 USB Interface

The USB interface is reserved.

### 2.7 Reset

Press the Reset button for three seconds or longer, and the ECU-C will automatically return to the default settings.

#### NOTICE

The historical power generation won't be cleared.

### 2.8 LED

The OK light will blink when ECU-C starts up, and it will keep on after registering.

The Comm light will be on when the ECU-C connects to EMA.

The Fault light will be on when the ECU-C breaks down.

## 3. Hardware Installation

### 3.1 Preparation

Make sure you have the following components ready before beginning to install the ECU-C:

- A broadband Internet connection available for your use.
- A broadband router with either a CAT5 Ethernet, or a wireless router .
- A laptop with a web browser (to view the APsystems EMA online monitoring application).
- A pre-programmed ECU-C.

### 3.2 Selecting an Installation Location for the ECU-C

- Choose a location that is electrically as close to the array as possible.
- The ECU-C is NOT rated for outdoor use, so if installing outdoors near a junction box or breaker panel, make sure you enclose it in an appropriate weatherproof NEMA electrical box.
- **Avoid to install in the place children can not touch.**

#### 1) Power Distribution Cabinet Installation

If you use the energy communicator in power distribution cabinet:

- Pull the four snap out with a screwdriver.

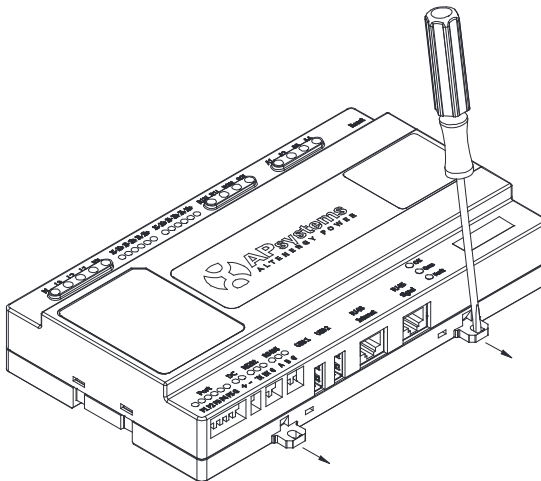

Figure 5

### 3. Hardware Installation

- Attach two buckles below in the edge of the guide, press two buckles above, then embed to the edge of the guide.

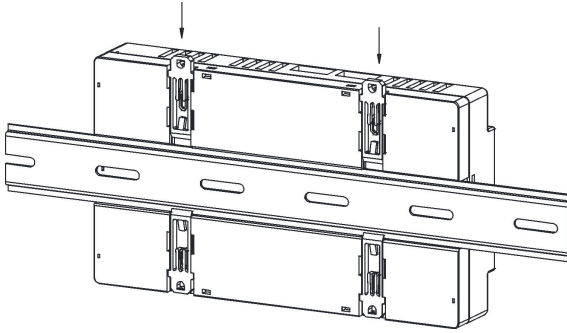

Figure 6



#### NOTICE

Do not put the antennas inside a metal box, that will block the signal.

#### 2) Using a Wall Mount

When mounting the ECU-C to a wall, make sure to select a cool, dry indoor location.

- According to the size of an icon, The energy communicator is fixed on the wall with two Wall screws or wall anchors.
- Four M4 screws + spacers are fixed to the wall, and the punch sizes are as follows:

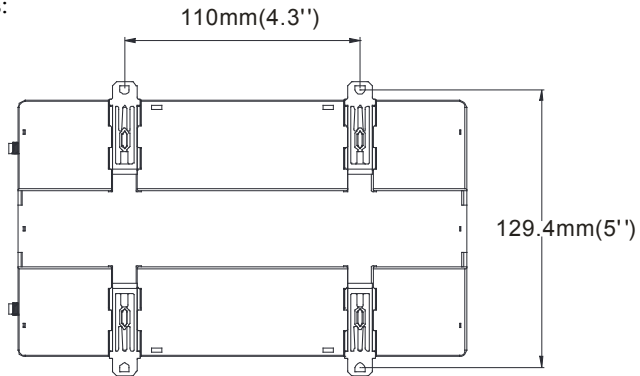

Figure 7



## 3. Hardware Installation

### 3.3 Cable Connections

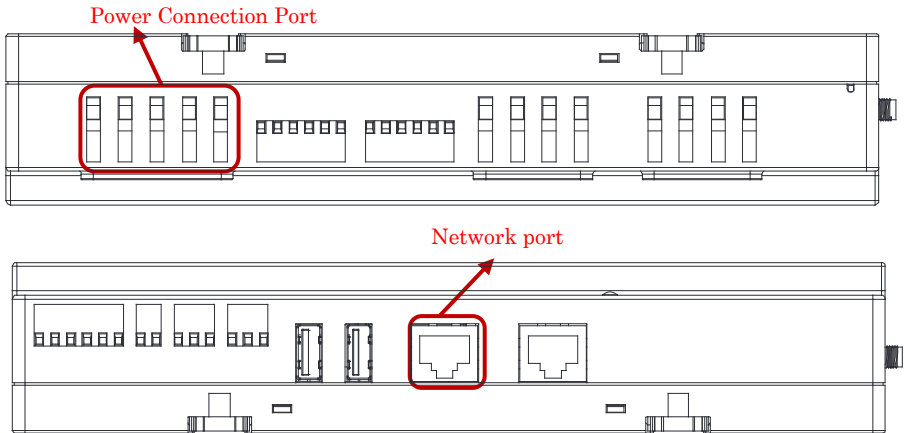

Figure 8

- Connect the power cable to the power connection port on the top of the ECU-C.(Can also be DC power supply).
- Connect the supplied LAN cable to the network port on the bottom of the ECU-C.

### 3.4 RJ45 Signal connection

Plug the RJ45 connector in the package to RJ45 Signal port.

### 3.5 Internet Connection

There are three different approaches to connecting the ECU-C to the Internet:

Option 1: Direct LAN cable connection.

- 1) Make sure the LAN cable is connected to the network port on the bottom of the ECU-C.
- 2) Connect the LAN cable to a spare port on the broadband router.

## 3. Hardware Installation

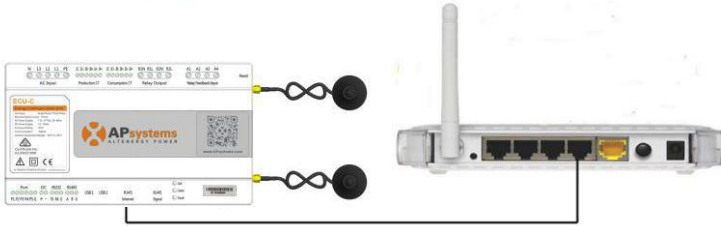

Figure 9

### Option 2: Wireless Connection.

Use ECU-C internal WLAN (see Managing the WLAN Connection, pg. 23).

### Option 3: Using a PLC bridge:

- 1) Make sure the LAN cable is connected to the network port on the bottom of the ECU-C.
- 2) Connect the LAN cable to the “send” unit of the PLC bridge.
- 3) Connect a LAN cable from the “receive” unit of the PLC bridge to a spare port on the broadband router (refer to the bridge users manual for specific operating instructions).

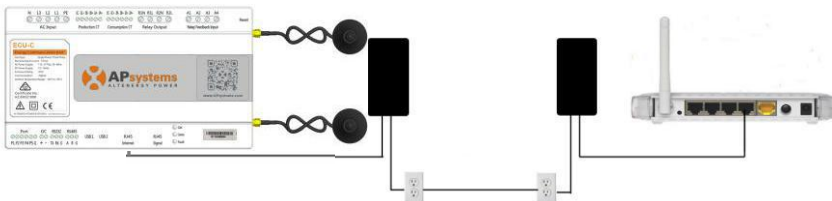

Figure 10

### NOTICE

The network cable in the package can be used to connect the ECU-C with PC directly. One side is connected with the ECU-C and the other side is connected with the PC. Then change the IP address and the network mask to 192.168.131.1 and 255.255.255.0, respectively.

### NOTICE

1. A PLC bridge uses the power line to communicate and requires both a “send” and “receive” unit.
2. The quality and length of the LAN cable will affect the ECU-C communication quality. You can use a Switch to enhance the communication quality if necessary.

# 3. Hardware Installation

## 3.6 Current transformer interface

By installing Current Transformer(CT), the integrated meter in ECU-C can measure the production&consumption power and energy. Please refer to the picture.

It is mandatory to install the current transformer on production and consumption side to get the anti-backflow function.

Anti-backflow function manages inverters one by one: it turns on/off each inverter through PLC communication, in order to get production inferior or equal to consumption.

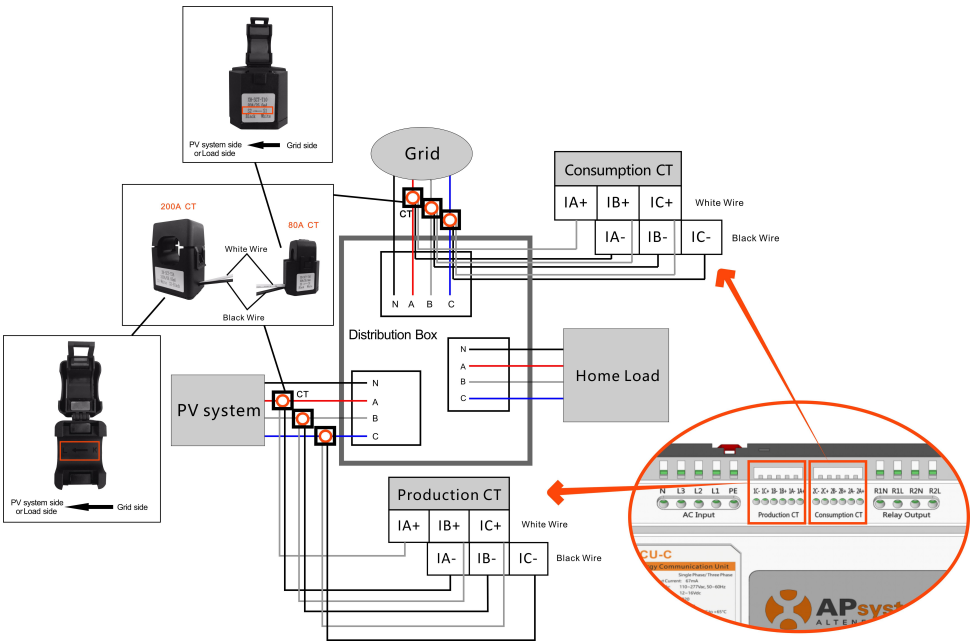

Figure 11



### NOTICE

Please ensure that the ECU-C is in a power off state when installing the transformer. APsystems can provide the current transformers, please contact us or our distributors.

## 3. Hardware Installation

### 3.7 Contactor connection

ECU-C provides two contact driver signal interface, two-way contact signal interface.

Interface	Interface description
R1L	The first road contactor drives the output L, and is connected with the power supply interface L1.
R1N	The first road contactor drives the output N, and is connected with the power supply interface N.
R2L	Second road contactor driver output L, with the power supply interface L1.
R2N	Second road contactor driver output N, with the power supply interface N.
A1 A2	First contact feedback signal input, non polarity.
A3 A4	Second way contactor feedback signal input, non polarity.

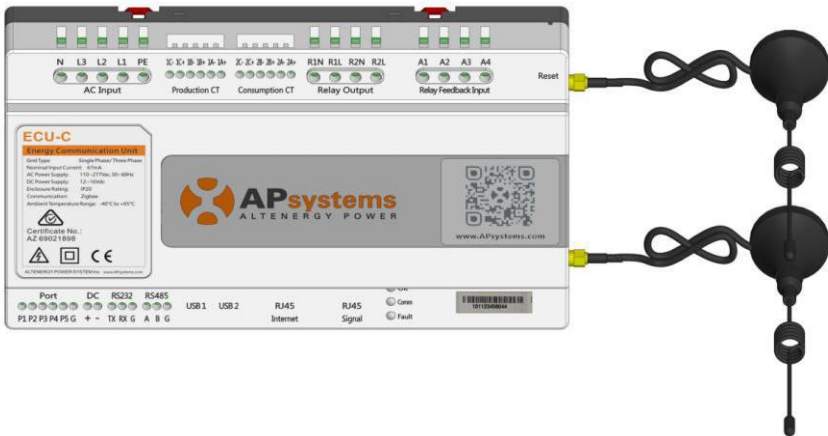

Figure 12

ECU-C automatic detection and judgment of the current power grid environment, through the drive signal interface to control the opening or closing of the contactor. The feedback signal interface and NO of contactor are often connected to inform the ECU that the contactor is effectively closed.

## 4. Basic Operation

### 4.1 Restore the factory set operation

The following diagram shows the connections on the bottom of APsystems the ECU-C.

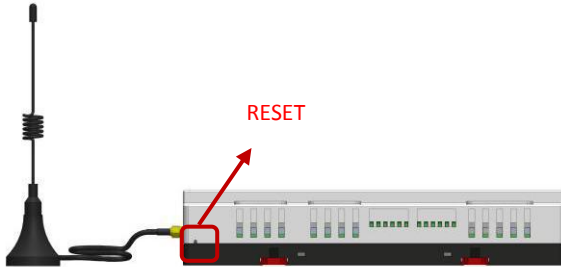

Figure 13

To restore the ECU-C's factory settings, simply press the "Reset" button for three seconds or longer. The unit will automatically return to its default settings.

# 5. Local Network Interface

## 5.1 Connecting to the ECU-C via the Local Wireless

1. Turn on the Wi-Fi function on PC or phone.
2. Scan the ECU's SSID which named "ECU-WIFI\_XXXX" (the "XXXX" refers to the last 4 numbers of the ECU-C ID), connect to the ECU-C's SSID. The first connection has no password.
3. Using a standard web browser on your computer, Enter the ECU's IP 172.30.1.1 into browser.

The ECU-C's "splash" screen is displayed.



Figure 14

## 5.2 Home Screen

Select "Home" at the top of the page.  
The Home Page is displayed.

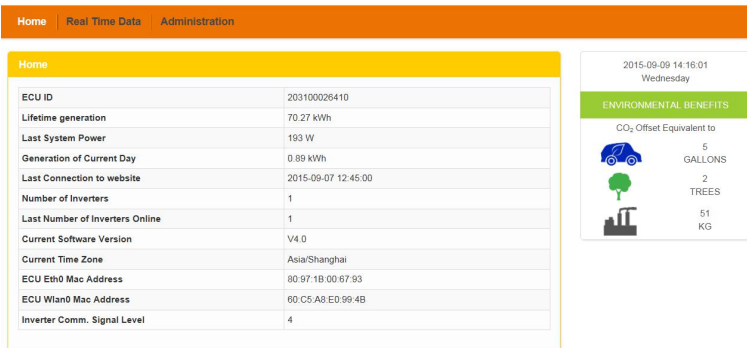

Figure 15

## 5. Local Network Interface

ECU-C ID:	This is a unique number that identifies this specific ECU-C.
Lifetime Generation:	Amount of power this system has generated during its lifetime.
Last System Power:	Amount of power the system was generating during its last polling cycle.
Generation of Current Day:	Amount of power that has been generated during the most current day.
Last connection to Website:	The last time the ECU-C checked into the central APsystems EMA database.
Number of Inverters:	Number of inverters that have programmed into the ECU-C.
Last Number of Inverters Online:	Number of inverters that are checking in with the ECU-C.
Current Software Version:	Current version of the firmware.
Current Timezone:	Time zone that has been programmed into the ECU-C.
ECU-C Eth0 Mac Address	Address of ECU-C's LAN.
ECU-C Wlan0 Mac Address	Address of the ECU-C's internal WLAN.
Inverter Comm. Signal Level	The communication strength between inverters and ECU-C. The range is 1-5, the higher the better.

# 5. Local Network Interface

## 5.3 Real-time Data Screen

### a) Real Time Data

To view the real-time system operation data statistics for your solar array, click “Real Time Data” from the ECU-C home screen to navigate to the real-time data screen.

The Real Time Data screen is displayed.

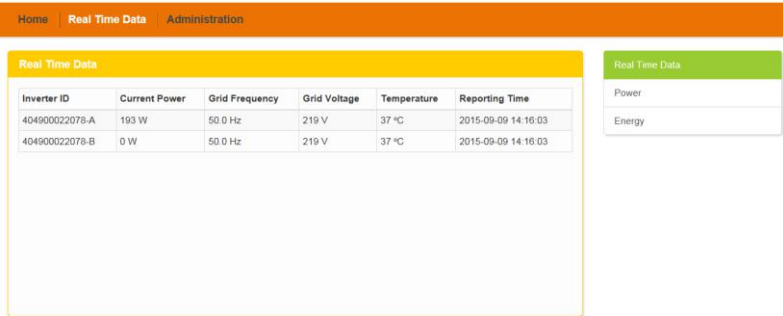

Figure 16

### b) Trend of system power

To view the system power of any period, click "Power" at the real-time data page.

The Trend of system power screen is displayed.



Figure 17

### c) Power generation statistics

Press “Energy” at the real-time data page to view the system power generation of your solar array.



## 5. Local Network Interface

The Power generation statistics screen is displayed.  
Performance data for the current week:



Figure 18

Performance data for the current month.



Figure 19

# 5. Local Network Interface

Performance data for the current year.

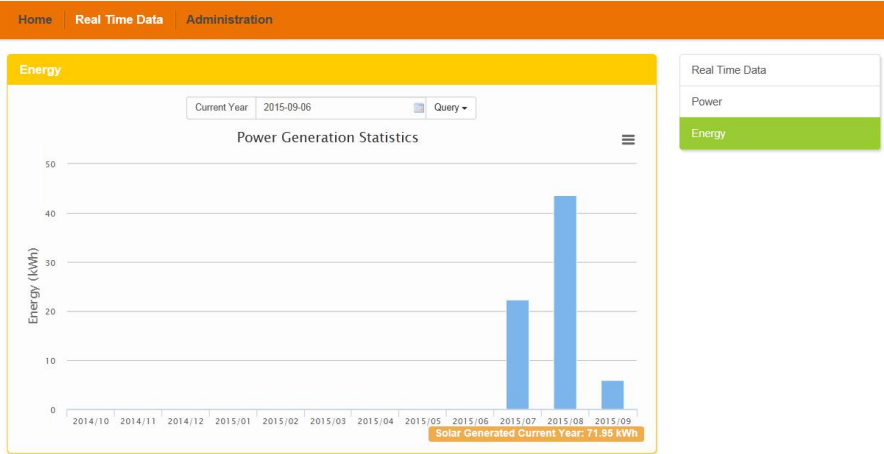

Figure 20

## 5.4 Administration Screen

### a) Managing Inverter IDs

The inverter IDs must be programmed into the ECU-C for the ECU-C to recognize the inverters. The ECU-C will NOT auto-sense the inverters.

Initial Programming of the ECU-C with the Inverter IDs.

#### NOTICE

The “Enter Inverter ID” window field will be blank if you have not yet entered any of the inverter IDs.

- 1) Select “Administration” at the top of the page.

# 5. Local Network Interface

The ID Management page is displayed.

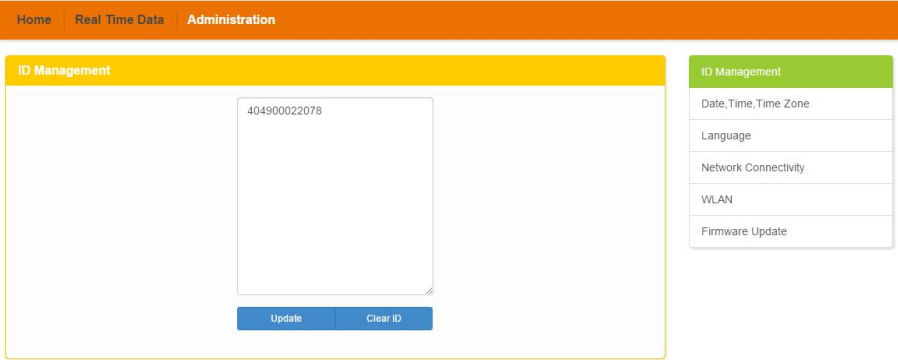

Figure 21

If you manually input the inverter IDs -

- 1) Enter each 12-digit inverter ID.
- 2) Once all the ID have been entered, press "Update". "ID updated successfully!" will displayed after a few seconds.

If using the Scanning Gun to input the inverter IDs -

- 1) Copy the scanned IDs into the ID Management box
- 2) Press "Update". The message "ID updated successfully !" will be displayed after few seconds.

## Adding Additional Inverter IDs

If the number of inverter ID displayed on the page is less than the actual number of inverters installed:

- 1) Select "Administration" at the top of the page.

The ID Management page with the existing inverter IDs is displayed.

# 5. Local Network Interface

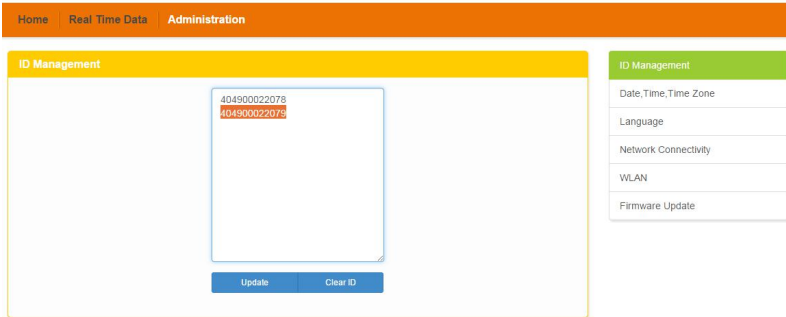

Figure 22

- 2) Scroll down to the end of the existing list.
- 3) Enter the new ID.
- 4) Press “Update”. The “ID updated successfully!” message will be displayed after few seconds.

## Deleting an Existing Inverter ID

If the number of inverter IDs displayed on the page is more than the actual number of inverters installed:

- 1) Select “Administration” at the top of the page.

The ID Management page with the existing inverter IDs is displayed.

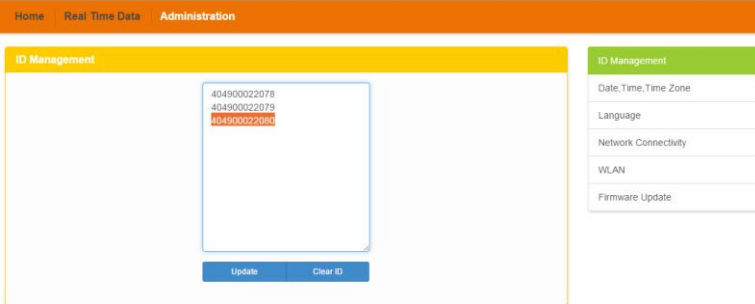

Figure 23

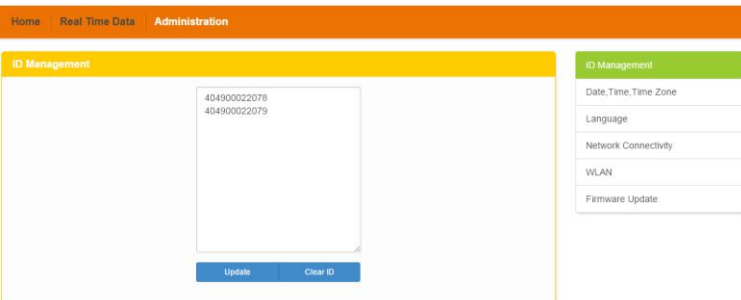

Figure 24

## 5. Local Network Interface

- 2) Highlight the IDs to be deleted from the list.
- 3) Press “Update”. The “ID updated successfully!” message will be displayed after few seconds.

### Modify an Existing Inverter ID

If the inverter ID displayed on the page does not match the actual inverters ID installed, modify the wrong inverters ID from “Input Inverter ID” section, then click “Update”. The message “ID updated successfully!” will be displayed after few seconds.

The ID Management page with the existing inverter IDs is displayed:

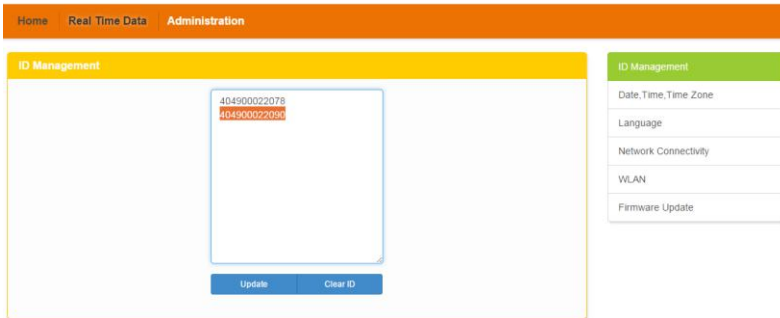

Figure 25

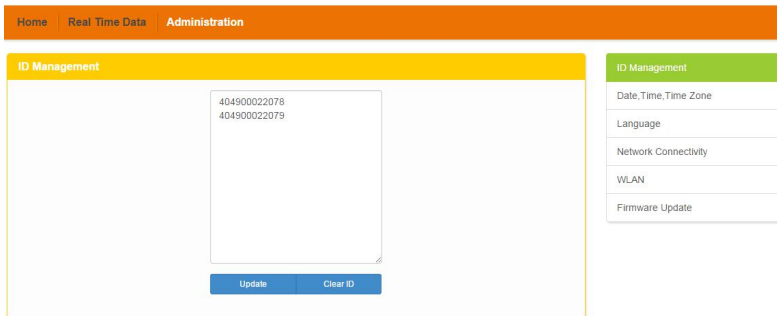

Figure 26

# 5. Local Network Interface

## Clearing inverter IDs

Pressing “Clear ID” deletes ALL of the inverter IDs from the list.

The ID Management page with the existing inverter IDs is displayed.

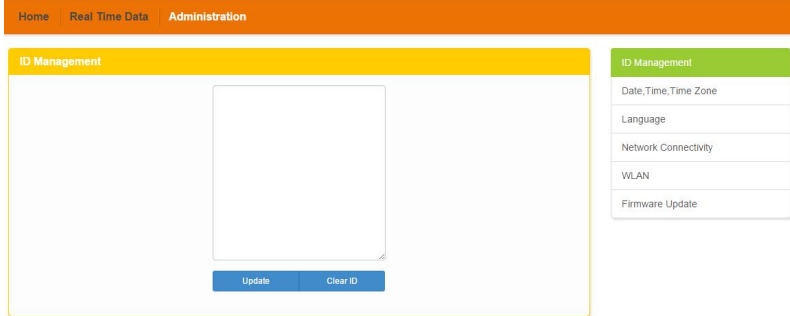

Figure 27

### NOTICE

Combine the above two steps when swapping out an inverter. Add the new inverter, and Delete the old one. Remember to follow up with the same process on the APsystems EMA because the ECU-C and EMA need to be in sync with each other.

### b) Changing the Date, Time Zone

It is critical for accurate power production reporting that the ECU-C is programmed with the correct date, time, and time zone.

- 1) Select “Administration” at the top of the page.
- 2) Select “Date, Time, Timezone”.

The Date, Time, Time Zone page is displayed:

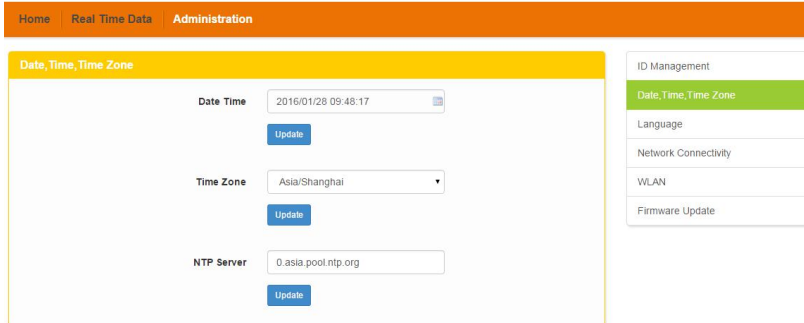

Figure 28

- 3) Adjust the correct date in the “Date Time” field
- 4) Select the correct time zone from the Time Zone pull down.

## 5. Local Network Interface

### NOTICE

You can skip step 3 by selecting the correct time zone.  
Selecting the correct time zone automatically updates both the date and current time.

#### c) Changing the Language

Users can switch language between English and Chinese.

- 1) Select “Administration” at the top of the page.
- 2) Select “Language”.

The Language management page is displayed:

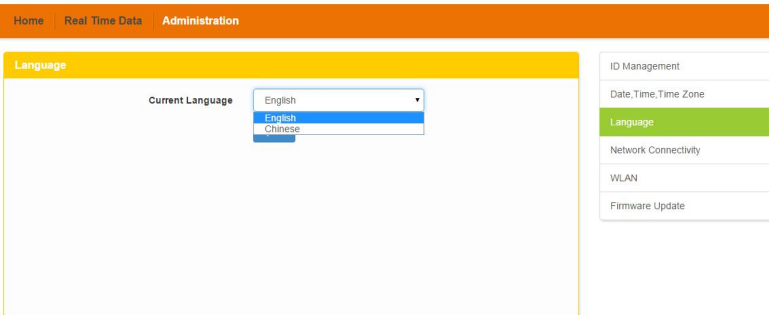

Figure 29

- 3) Select the language from the Current Language pull down.
- 4) Press “Update”.

#### d) Managing the Network Connection

The default network connection setting for the ECU-C is “DHCP,” which allows the ECU-C to automatically establish a connection assignment from the router. The ECU-C can be assigned a static.

IP Address if the network design requires it.

- 1) Select “Administration” at the top of the page.
- 2) Select “Network Connectivity”.

The Network Connectivity page is displayed:

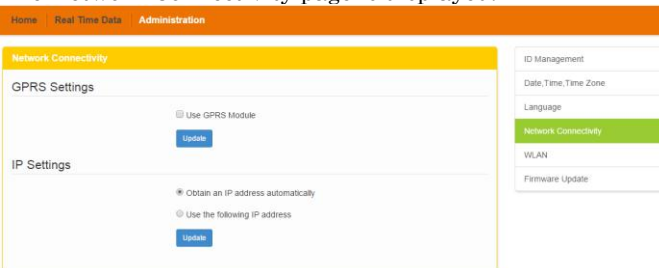

Figure 30

## 5. Local Network Interface

- 3) Select “Obtain an IP address automatically”.
- 4) Press “Update”.

### e) Managing the WLAN connection

The ECU-C can both work in two modes: WLAN and Local Wireless Access. In WLAN mode, the ECU-C can connect to a router by Wi-Fi. In Local Wireless Access mode, user’s phone or PC can connect to ECU-C to access local web.

WLAN mode

- 1) Select “Administration” at the top of the page.
- 2) Select “WLAN”, and click “WLAN” tab.



Figure 31

- 3) The ECU-C will display the available networks.  
Select the button next to the available network that you wish to access SSID, and a password entry field will be displayed below the network name. Enter the password into the password entry field, then click “Connect”.

The WLAN Connectivity page is displayed.

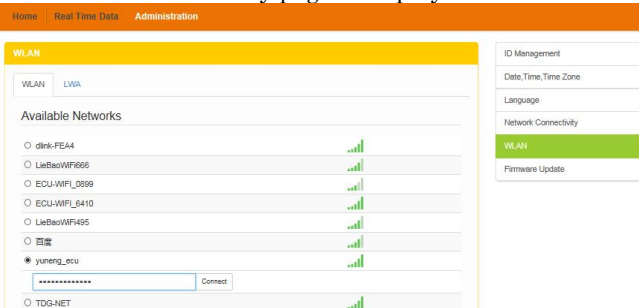

Figure 32

- 4) If ECU-C has connected to the router, it will display the SSID and IP address. Now you can connect by PC or phone to the router. Enter the ECU-C’s IP (e.g., 192.168.1.112) into the browser to access the local web.



# 5. Local Network Interface

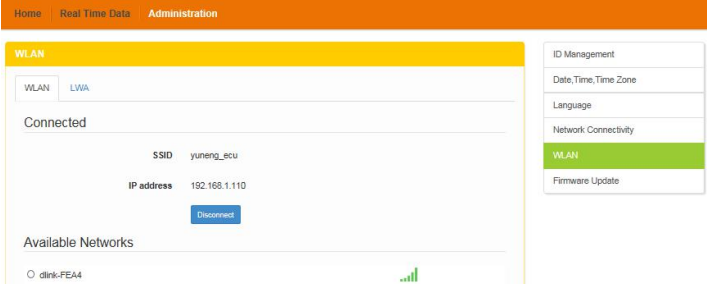

Figure 33

## Local Wireless Access mode

- 1) Scan the ECU-C's SSID on PC and phone, and connect to ECU-C. Enter the ECU-C's IP 172.30.1.1(The IP is fixed) into browser to access the local web.
- 2) On the page, you can modify SSID, Channel, Safe Type and Password. If you don't select the Safe Type, the Password is hidden.

The Local Wireless Access page is displayed.

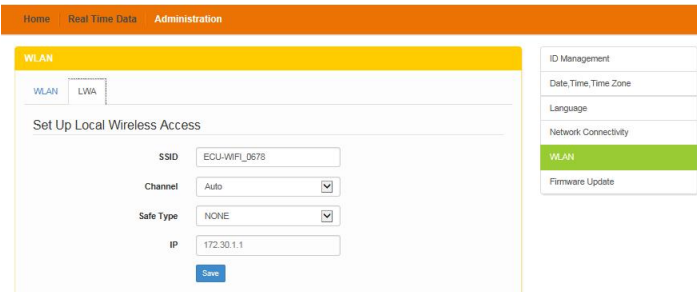

Figure 34

## f) Firmware Update

Select the ECU-C upgrade package, and click OK to upgrade ECU-C firmware. The upgrade package can be downloaded at [www.APsystems.com](http://www.APsystems.com).

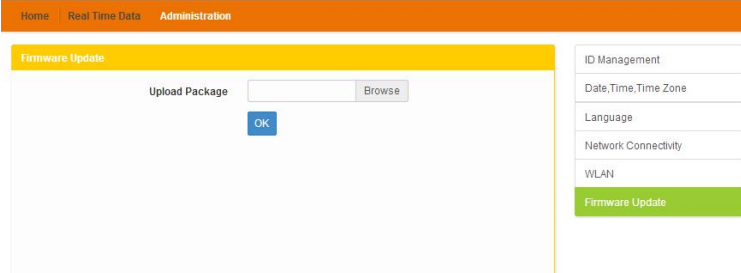

Figure 35

# 6.Remote ECU-C Management (EMA)

The ECU-C has been designed with remote connect functionality. You can access this remote functionality through the APsystems Energy Monitoring & Analysis (EMA) website, using your installer login credentials. Changes made remotely through the EMA do not take effect until the ECU-C's next reporting cycle. The ECU-C must first be installed with Internet connectivity.

The ECU-C remote functionality allows you to do the following:

- Set Time Zones
- Manage Inverter IDs

There are additional ECU-C functions available but the instructions are not outlined in this document. If you need to access one of the following features, please contact APsystems Technical Support:

- Change system parameters
- Turn the inverters ON and OFF
- Reset GFDI
- Reset Power Settings



## NOTICE

This section of the documentation assumes you have a working knowledge of the APsystems EMA.

1) Log onto your APsystems EMA account.

Your Customer List within the Installer Portal is displayed.

2) Select the customer's ECU-C you want to manage and click on the username in the "Customer Account" column.

ID	Customer Account	ECU ID	True Name	Country	State	City	System Size(KW)	Register Date	System Status	Action
1	<a href="#">cztbor</a>	203000014617	Mike	United States	WA	La Center		2015-11-18	<span style="color: green;">●</span>	Delete
2	<a href="#">Steven Langer</a>	203000024740	Steven Langer	United States	WA	Camas	8	2015-11-10	<span style="color: green;">●</span>	Delete
3	<a href="#">NickBrooks</a>	20300006557	Nicolas Brooin	United States	WA	Bellevue	10.0	2015-05-05	<span style="color: red;">●</span>	Delete
4	<a href="#">pawncr</a>	203000015787	Paul Userer	United States	NY	Smithtown	5	2015-01-31	<span style="color: green;">●</span>	Delete
5	<a href="#">dkleszcz</a>	203000016109	Dan Kleszcz	United States	CA	Camallo		2014-12-24	<span style="color: green;">●</span>	Delete
6	<a href="#">ethomas</a>	203000012880	Earl Thomason	United States	WA	Vancouver	7.5	2014-11-14	<span style="color: green;">●</span>	Delete
7	<a href="#">jlopez</a>	203000014540	Jaime Lopez	United States	CA	South Gate		2014-10-07	<span style="color: green;">●</span>	Delete
8	<a href="#">Schert</a>	203000014624	Phil Schert	United States	CA	Newbury Park	8.25	2014-10-03	<span style="color: green;">●</span>	Delete
9	<a href="#">Ribe</a>	203000012755	Rachael Ribe	United States	WA	Spokane	3.3	2014-06-20	<span style="color: red;">●</span>	Delete
10	<a href="#">PVUSA</a>	203000008668	Steve Coonen	United States	California	Davis		2014-02-07	<span style="color: red;">●</span>	Delete

Figure 36

# 6.Remote ECU-C Management (EMA)

## 6.1 ECU-C Configuration/ECU-C Status Page

ECU-C SETTING page under the Remote control page.

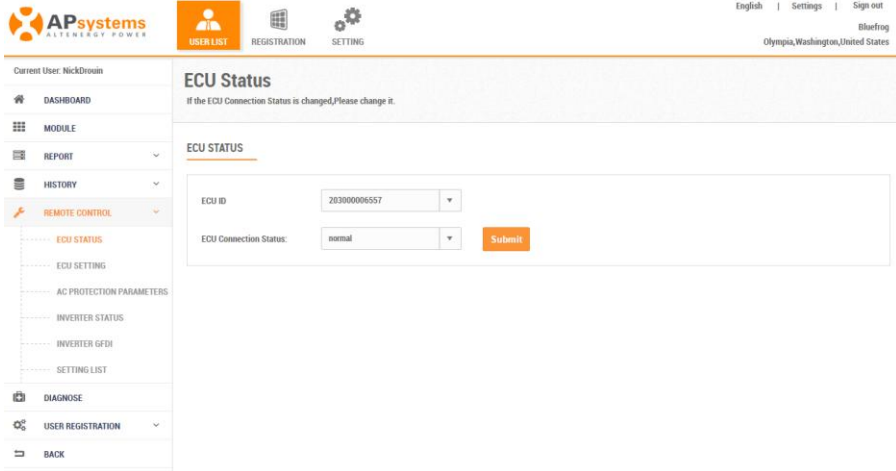

Figure 37

The ECU-C SETTING tab allows you to:

### Set Time Zones

- The ECU-C time zone can be set or adjusted remotely through the ECU-C setting tab. If the time zone is not properly set, the solar production data will not post properly on the EMA site.

### Load Inverter IDs

- Once the ECU-C has been installed you can access the ECU-C remotely to add the inverter IDs. Until the inverter IDs are loaded, the ECU-C will not be able to collect data from the inverters.

### Update Inverter ID list

- If an inverter(s) is added or swapped for a new unit, then the ECU-C's programmed list of inverters will need to be updated.

# 6. Remote ECU-C Management (EMA)

## 6.2 Setting the ECU-C Time Zone

- 1) Click the remote control menu to enter the remote settings page
- 2) Select the “ECU-C SETTING” tab.

The ECU-C Configuration page is displayed.

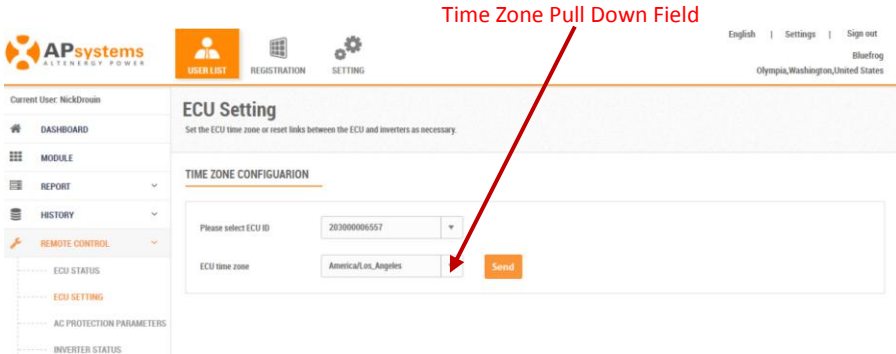

Figure 38

- 3) Using the “Time Zone” pull down field, select the appropriate time zone.
- 4) Press “Send”.

## 6.3 Managing Inverter IDs and Updating the Inverter ID List

- 1) Select the “ECU-C SETTING” tab.

The Inverter Links Configuration page is displayed

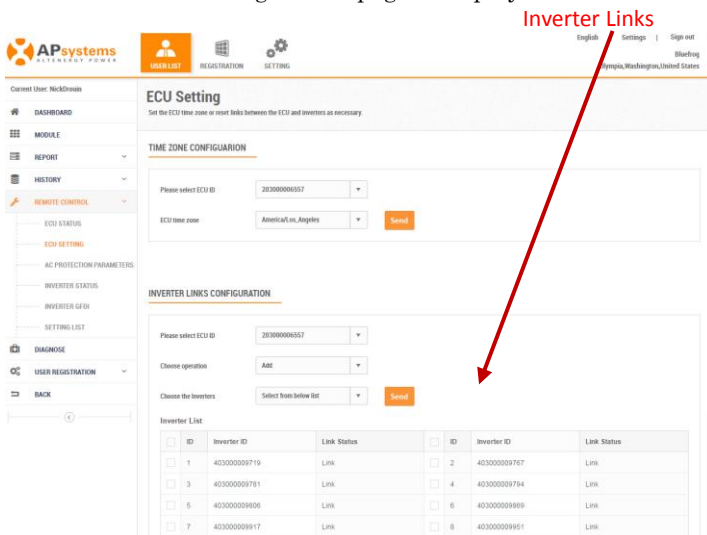

Figure 39

## 6.Remote ECU-C Management (EMA)

### Operation Selection (Add or Delete)

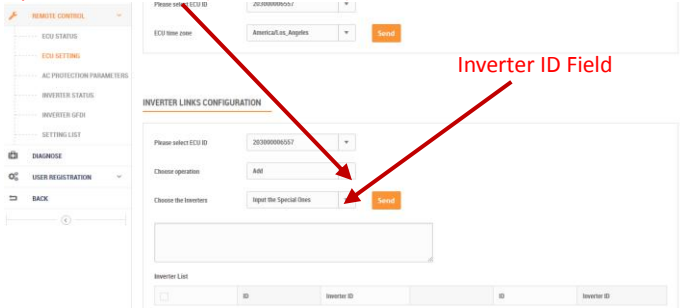

Figure 40

Adding Complete List of Inverter IDs for a Newly Installed System

There are two different approaches to add the inverter IDs:

Option 1: Webpage -

1. Select Add inverter based on registration list
  - 1) Select “Add” in Operation Selection.
  - 2) Select the Inverters “select from below list”.
  - 3) Select the inverter to be added
  - 4) Press “Send”.
2. The specified inverter ID
  - 1) Select “Add” in Operation Selection.
  - 2) Select the Inverters “input the special ones”.
  - 3) Enter all of the inverter IDs into the Inverter ID Field(one per line).
  - 4) Press “Send”.

Option 2: Mobile phone-

- 1) Log onto ArrayAPP.
- 2) Select user account.
- 3) Select Link ECU.
- 4) Press “Send”.

Delete IDs from Inverter List

1. Select Delete inverter based on registration list
  - 1) Select “Delete” in Operation Selection.
  - 2) Select the Inverters “select from below list”.
  - 3) Select the inverter to be deleted.
  - 4) Press “Send”.
2. The specified inverter ID
  - 1) Select “Delete” in Operation Selection
  - 2) Select the Inverters “input the special ones”.
  - 3) Enter all of the inverter IDs into the Inverter ID Field(one per line).
  - 4) Press “Send”.
3. Delete all
  - 1) Select “Clear” in Operation Selection.
  - 2) Press “Send”.

## 7. Technical Data

Model	ECU-C
<b>Communication Interface</b>	
Communication Method	ZigBee
Integrated Wi-Fi	802.11g/n
Ethernet	10/100M Auto-sensing, Auto-negotiation
USB Interface	Standard
RS232	Standard
RS485	Standard
RJ45	Standard
<b>Power Supply</b>	
AC Power Supply	110~277VAC, 50~60Hz Single Phase - (3-Phase Optional)
DC Power Supply	12~16V
Power Consumption	3W
<b>Mechanical Data</b>	
Dimensions (W×H×D)	210 x 120 x 41mm (8.3" x 4.7" x 1.6")
Weight	500g (1.1lbs)
Ambient Temperature Range	-40°C to +65°C (-40°F to 149°F)
Cooling	Nature Convection; No Fans
Enclosure Environmental Rating	Indoor - IP20 (NEMA 1)
<b>Other Features</b>	
Grid Type	Single Phase/ Three Phase
Relay Driver	Control external AC contact or relay
Relay Feedback	Get relay signal, could do anti-backflow control, and energy management
Digital Input	For external control device connection
CT Sensor	Production and consumption metering
Meter Accuracy	Integrated PV production metering (+/- 0.5% via CT) and optional consumption monitoring (+/- 2.5% via CT)
<b>Compliance</b>	
Compliance	IEC/EN61010-1, EN61000-6-2, EN61000-6-4, 2014/53/EU, EN301489-1/-17, EN62311, EN 300328

Specifications subject to change without notice.

Please ensure you are using the most recent update found at [www.APsystems.com](http://www.APsystems.com).

2018/1/16 Rev1.5

## :: WEEE (for Europe )



### Disposal of your old appliance

1. When this crossed-out wheeled bin symbol is attached to a product, it means the product is covered by the European Directive 2002/96/EC.
2. All electrical and electronic products should be disposed of separately from the municipal waste stream via designated collection facilities appointed by the government or the local authorities.
3. The correct disposal of your old appliance will help prevent potential negative consequences for the environment and human health.
4. For more detailed information about disposal of your old appliance, please contact your city office, waste disposal service or the shop where you purchased the product.

## Contact Information

ALTENERGY POWER SYSTEM Inc.

[www.APsystems.com](http://www.APsystems.com)

### **APsystems Jiaxing China**

No. 1, Yatai Road, Nanhu District, Jiaxing, Zhejiang

Tel: +86 573 8398 6967

Mail: [info@altenergy-power.com](mailto:info@altenergy-power.com)

### **APsystems Shanghai China**

B403 No. 188, Zhangyang Road, Pudong, Shanghai

Tel: +86 021 3392 8205

Mail: [info@altenergy-power.com](mailto:info@altenergy-power.com)

### **APsystems Australia**

Suite 502, 8 Help Street, Chatswood NSW 2067 Australia

Tel: +61 (0)2 8034 6587

Mail: [info@altenergy-power.com](mailto:info@altenergy-power.com)

### **APsystems America**

600 Ericksen Ave NE, Suite 200 Seattle, WA 98110

Tel: 844-666-7035

Mail: [info@APsystems.com](mailto:info@APsystems.com)

### **APsystems Europe**

Rue des Monts dor ZAC de Follieuses Sud-Les Echets 01700 Miribel, France

Tel: +33-481 65 60 40

Mail: [emea@APsystems.com](mailto:emea@APsystems.com)