



Installation / User Manual

APsystems ECU-3

Energy Communication Unit (ECU)

Version: 4

© All Rights Reserved

Rev 1.3

Table of Contents

| | |
|--|-----------|
| Introduction | 2 |
| Interface Explanation | 3 |
| Interface Layout..... | 3 |
| Power Connection Port..... | 3 |
| RS232 Serial Port..... | 3 |
| RJ45 Ethernet Network Port..... | 4 |
| USB Interface..... | 4 |
| Reset..... | 4 |
| Hardware Installation | 5 |
| Preparation..... | 5 |
| Selecting an Installation Location for the ECU..... | 5 |
| Cable Connections..... | 7 |
| Internet Connection..... | 7 |
| Power Up ECU..... | 9 |
| ECU Initialization Sequence | 9 |
| Step 1: Power on ECU..... | 10 |
| Step 2: ECU time zone setting..... | 12 |
| Step 3: EMA Monitoring..... | 12 |
| Basic Operation | 13 |
| Menu Structure..... | 13 |
| Restore the factory set operation..... | 14 |
| Troubleshooting..... | 15 |
| Local Network Interface | 16 |
| Connecting to the ECU via the LAN..... | 16 |
| Connecting directly to the ECU via wired LAN..... | 16 |
| Connecting to the ECU via the Wi-Fi hotspot..... | 18 |
| Home Screen..... | 19 |
| Real-time Data Screen..... | 20 |
| Administration Screen..... | 22 |
| Remote ECU Management (EMA) | 29 |
| ECU Configuration/ECU Status Page..... | 30 |
| Setting the ECU Time Zone..... | 31 |
| Managing Inverter IDs and Updating the Inverter ID List..... | 31 |
| Technical Data | 33 |

Introduction

The APsystems Energy Communication Unit (ECU) is the information gateway for our microinverters. The unit collects module performance data from each individual microinverter and transfers this information to an Internet database in real time, requiring only a single data and power cable. Through the APsystems Energy Monitoring and Analysis software, the ECU gives you precise analysis of each microinverter and module in your solar installation from any web-connected device. The ECU's integrated http webserver offers the simplest and most flexible network integration of any data logger on the market. The user-friendly browser-based interface lets you access your solar array in seconds.

Features

- Collects individual module and microinverter statistics
- Communicates in real time
- Requires no additional wiring

The APsystems Microinverter is used in utility-interactive grid-tied applications, and is made up of three key elements:

- APsystems Microinverter
- APsystems Energy Communication Unit (ECU)
- APsystems Energy Monitoring and Analysis (EMA) web-based monitoring and analysis system

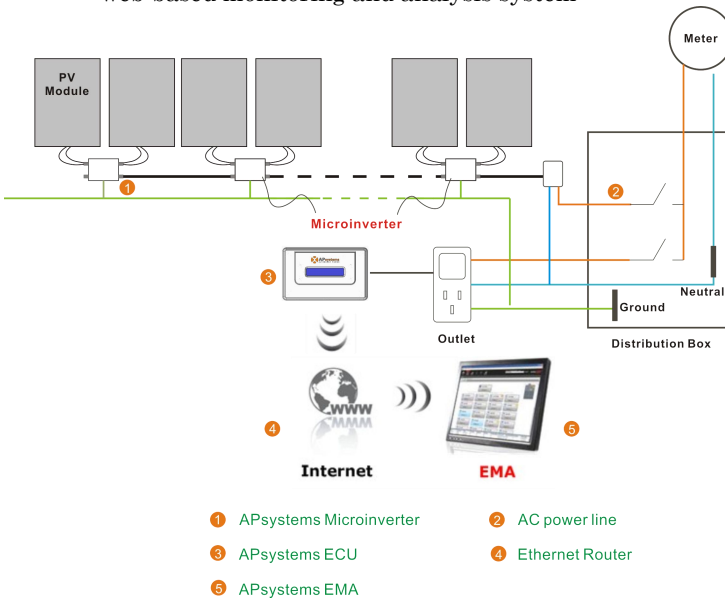

Figure 1

Interface Explanation

Interface Layout

The ECU interface includes, from left to right, are power connection port, serial port, network port, USB port, and Reset.

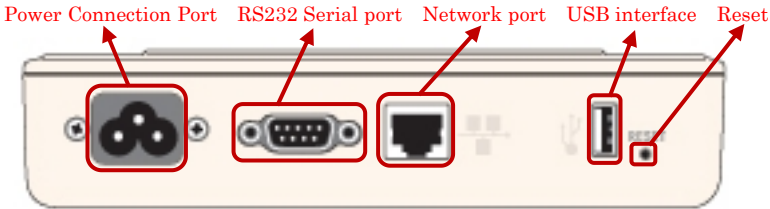

Figure 2

Power Connection Port

The power connection port connects power through the power line.



Figure 3

RS232 Serial Port

You can connect a GPRS module to the RS232 serial port. Select GPRS module to connect to the network on the “Network Connectivity” page, and communicate with the EMA to check the system data.



Figure 4

Interface Explanation

RJ45 Ethernet Network Port

The ECU allows the user to communicate with the EMA, or log in to the ECU's local page in the absence of the wired LAN and WLAN, to set up the system and view the system data via Ethernet network port.

USB Interface

The USB interface is reserved.

Reset

Press the Reset button for three seconds or longer, and the ECU will automatically return to the default settings.

NOTE: The historical power generation won't be cleared.



Hardware Installation

Preparation

Make sure you have the following components ready before beginning to install the ECU:

- A dedicated standard AC electrical outlet (located electrically as close to the array as is possible).
- A broadband Internet connection available for your use.
- A broadband router with either a CAT5 Ethernet, or a wireless router ..
- A laptop with a web browser (to view the APsystems EMA online monitoring application).
- A pre-programmed ECU.

Selecting an Installation Location for the ECU

- Choose a location that is electrically as close to the array as possible – preferably a dedicated outlet installed directly to the solar array’s sub-panel.
- The ECU is NOT rated for outdoor use, so if installing outdoors near a junction box or breaker panel, make sure you enclose it in an appropriate weatherproof NEMA electrical box.

1) Using an Electrical Mounting Din Rail

- Loosen the two (2) M3 mounting screws on the back of the ECU and rotate the two (2) rail holders so that the holders are above the ECU.

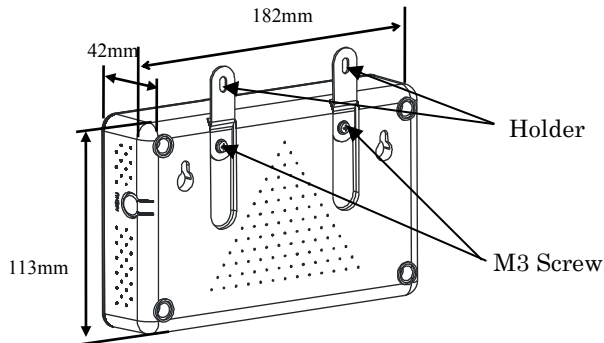

Figure 5

Hardware Installation

- Attach the ECU to the mounting rail with machine screws.

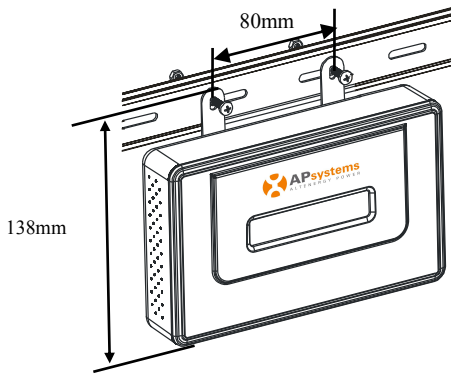

Figure 6

2) Using a Wall Mount

When mounting the ECU to a wall, make sure to select a cool, dry indoor location.

- Depending on the wall surface you are mounting the ECU to, use either two (2) #8 drywall screws or wall anchors, installed 130 mm apart. The drywall screws and wall anchors are NOT included in the ECU kit.
- Align and slide the ECU onto the mounting screws.

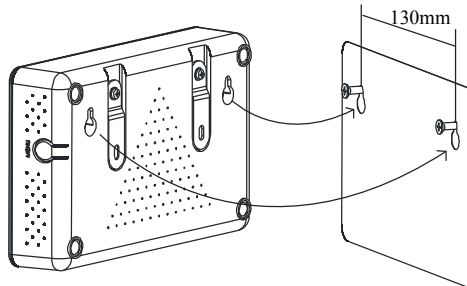

Figure 7

***Best Practice:** Install and connect the ECU to the Internet (see instructions below) while the rest of the array is being installed. Doing so allows the ECU to automatically update its internal software while the rest of the physical installation is underway. The ECU will then communicate with the inverters when the installation is complete and the array is energized.*

Hardware Installation

Cable Connections

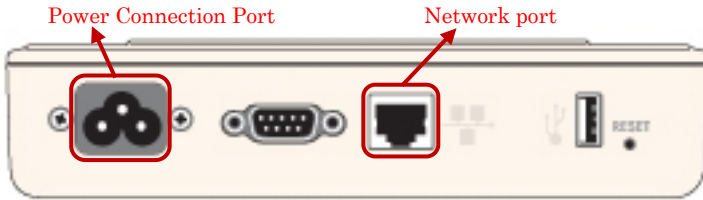

Figure 8

- Connect the supplied power cable to the power connection port on the bottom of the ECU.
- Connect the supplied LAN cable to the network port on the bottom of the ECU.

Internet Connection

There are three different approaches to connecting the ECU to the Internet:

Option 1: Direct LAN cable connection.

- 1) Make sure the LAN cable is connected to the network port on the bottom of the ECU.
- 2) Connect the LAN cable to a spare port on the broadband router.



Figure 9

Option 2: Wireless Connection.

Use ECU internal WLAN (see Managing the WLAN Connection, pg. 25).

Hardware Installation

Option 3: Using a PLC bridge:

- 1) Make sure the LAN cable is connected to the network port on the bottom of the ECU.
- 2) Connect the LAN cable to the “send” unit of the PLC bridge.
- 3) Connect a LAN cable from the “receive” unit of the PLC bridge to a spare port on the broadband router (refer to the bridge users manual for specific operating instructions).

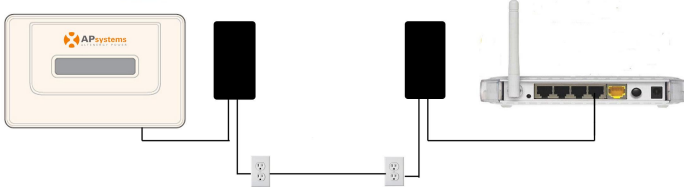

Figure 10

NOTE: The network cable in the package can be used to connect the ECU with PC directly. One side is connected with the ECU and the other side is connected with the PC. Then change the IP address and the network mask to 192.168.131.1 and 255.255.255.0, respectively.



NOTE: 1. A PLC bridge uses the power line to communicate and requires both a “send” and “receive” unit.
2. The quality and length of the LAN cable will affect the ECU communication quality. You can use a Switch to enhance the communication quality if necessary.



Hardware Installation

Power Up ECU

- Make sure the power cable is properly connected to the power port on the bottom of the ECU.
- Plug the power cable into a dedicated standard AC electrical outlet.

WARNING: Make sure to use a dedicated outlet for the ECU. Do NOT plug any other devices into the same outlet as the ECU.

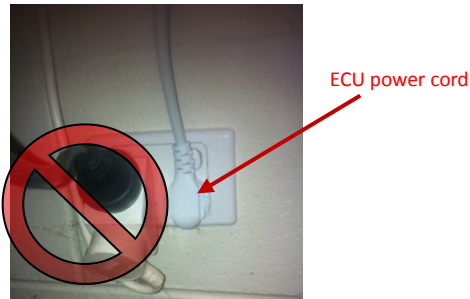

Figure 11

WARNING: Do NOT plug the ECU into a power strip, surge protector or uninterruptable power supply (UPS). The surge suppression and/or filtering on these sorts of devices will substantially diminish PLC performance.



ECU Initialization Sequence

Once power is supplied to the ECU, it automatically steps through a series of initialization screens on its LCD display.

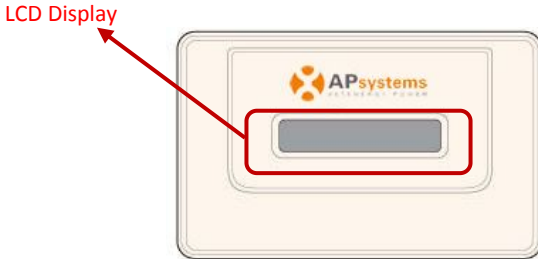

Figure 12

Step 1: Power on ECU

The following information will be displayed on the LCD after ten seconds.

- 1) Loading the software firmware:

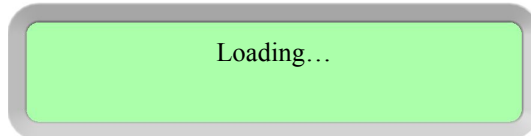

Figure 13

- 2) Waiting user to enter the inverter IDs on local web. Alternate displaying 1 and 2 for every 5 seconds:

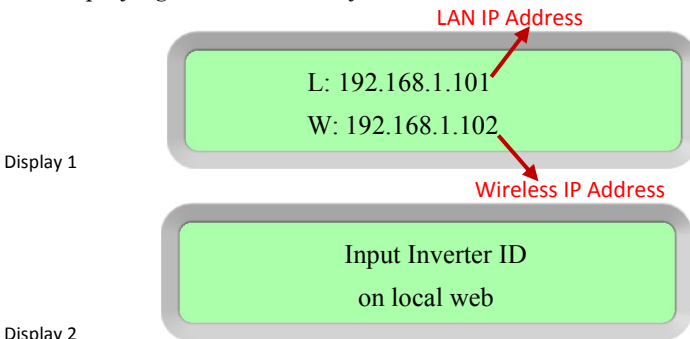

Figure 14

A word about network communication protocols: The ECU needs to have access to the router via a LAN IP address. The ECU will only search for and obtain a Dynamic Host Configuration Protocol (DHCP) IP address during its powering up sequence.

For example, the LCD screen on the front of the ECU displays a LAN IP address such as "192.168.1.101" if the connection to the router is successful (the IP address will vary based on the router supplier, so check with the user manual for specifics). If, however, the LCD displays "192.168.131.228", the ECU-router connection has not been successful, in which case you'll need to check all of the cabling connections and reboot the ECU by removing the power cable for a few seconds and reconnecting.

ECU Initialization Sequence

NOTE: The complete initialization sequence can take several minutes (up to 15 minutes depending on the complexity of the installation).



3) Operation interface. Alternate displaying 3 and 4, for every 1 minute:

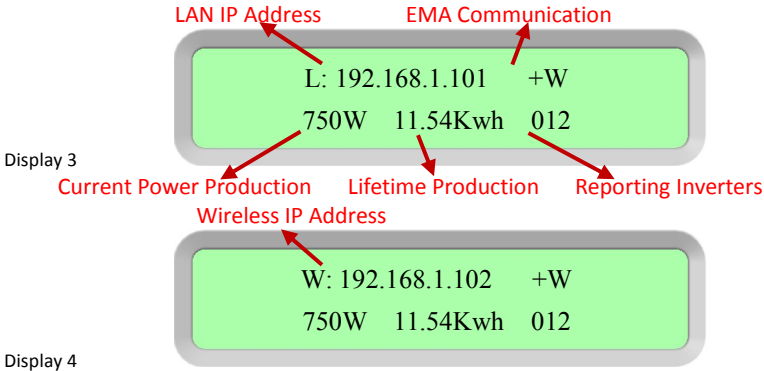

Figure 15

LAN IP Address:

When the ECU connects to the internet via LAN cable, the LCD screen on the front of the ECU displays a LAN IP address such as “192.168.1.101”, if the connection to the router is successful (the IP address will vary based on router supplier, so check with the user manual for specifics). If, however, the LCD displays “192.168.131.228”, the ECU-router connection has not been successful, in which case you’ll need to check all of the cabling connections and reboot the ECU by removing the power cable for a few seconds and reconnecting.

Wireless IP Address:

When the ECU connects to the internet by WiFi, enter the wireless IP address into the computer internet browser to login to the ECU’s local network interface.

EMA Communication:

A “+W” indicates that the ECU is communicating with the APsystems EMA via the Internet. “-W” is an indication that there is a problem and the ECU is not communicating with the APsystems EMA. Need to setup the security authority to offer Auto IP configuration.

Current Power Production:

What the solar array is producing currently (in Watts).

Lifetime Production:

The lifetime power output of the system (in kWh).

ECU Initialization Sequence

Reporting Inverters:

The number of inverters reporting into the ECU. If the number is followed by an “!”, then the number of reporting inverters does not match the number of IDs that have been programmed into the ECU.

NOTE: The inverter IDs must be programmed into the ECU for the ECU to recognize the inverters. The ECU will NOT auto-sense the inverters (see Managing Inverter IDs pg. 20).



Step 2: ECU time zone setting

- Enter the IP address shown on the ECU LCD into the internet browser, and then open the web page.
- Click “Administration”, then “Date, Time, Time zone”. In the corresponding box, enter local date/time/time zone, and click Update after finished. For details, refer to Date, Time Zone management, pg.25.

Step 3: EMA Monitoring

After the ECU displays “+W”, contact the installer or APsystems technical support and they will setup an EMA account with User Name and Password, then complete EMA management (see pg. 28).

Basic Operation

The APsystems ECU has a two-line, 40-character LCD display with alphanumerics. Set the mode using a single button.

NOTE: The ECU functions as a gateway and monitors the microinverters that are connected to the PV modules. Therefore, the communication between inverters and ECU does not affect the inverters' performance, even if ECU drops inverters. The power production data collected by ECU is for reference only; please check the power meter for the real power production of the whole system.



Menu Structure

You can access the ECU's menu by pressing and holding the Menu Button on the side of the ECU for 2 seconds.

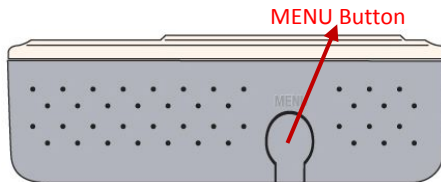

Figure 16

NOTE: The Menu Button will only cycle through its menu selections once the ECU has been successfully initialized.



The ECU has the following menu structure (displayed on LCD screen):

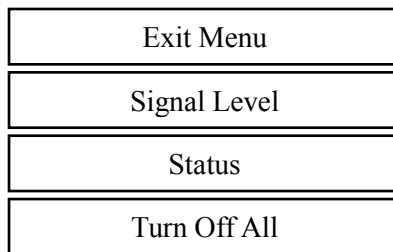

Figure 17

Press and hold the MENU Button, releasing the button to gain access to the functionality of each menu item.

- Exit Menu: Return the ECU to the normal operating screen (see Operating Interface, pg. 10).
- Signal Level: The communication strength between the inverters and the ECU is measured from 1-5. More “=” displayed means better signal strength.

Basic Operation

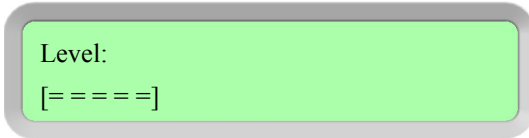

Figure 18

Status: Report both the number of inverters that should be connected to the ECU (Total), and the number that are actually connected (Connected). These numbers should match.

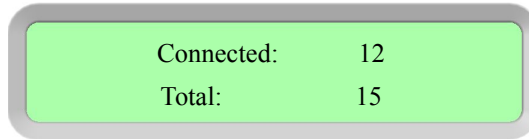

Figure 19

Turn off all: Turn off the entire system. Choose "Ok", and the system of inverters will be turned off. Choose "Cancel", and ECU will exit the menu.

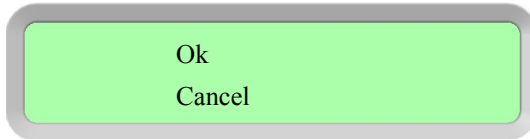

Figure 20

The screen will revert back to the main menu if the menu button is not pressed again within a minute.

NOTE: The above operation should be done under the guidance of a support technician.



Restore the factory set operation

The following diagram shows the connetions on the bottom of APsystems the ECU.

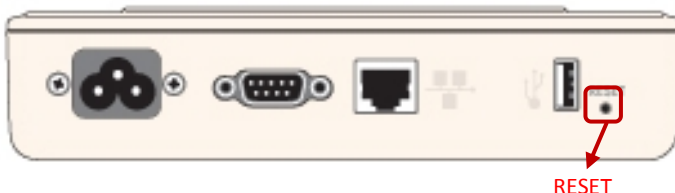

Figure 21

To restore the ECU's factory settings, simply press the "Reset" button for three seconds or longer. The unit will automatically return to its default settings.

Basic Operation

Troubleshooting

Potential Problems and Solutions

IP Address Problem:

If the LAN IP address displayed on the ECU's LCD does not match the subnet on your internal network and shows "192.168.131.228", it means that it was unsuccessful in obtaining a DHCP IP address from your router.

- Check network connectivity to the router or other DHCP server. You may need to contact your Internet Service Provider or refer to your router documentation for troubleshooting assistance.

LCD Displays "-W":

- The ECU could not connect to the APsystems website. Check network connectivity to the router. You may need to contact your Internet Service Provider or refer to your router documentation for troubleshooting assistance.
- The communication between the microinverters and the ECU is not correct. Check the communication between the microinverters and and ECU.

LCD Display "I":

The number of installed units doesn't match the microinverter-count. This may indicate that the ECU is having difficulty communicating over the power line. It could also be caused by low sunlight, resulting in module voltage that is too low for the microinverter to power up.

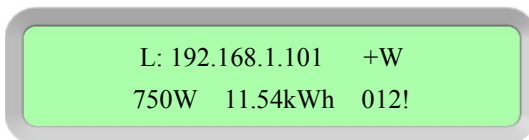

Figure 22

- Plug the ECU into an electrical socket in a different location. Keep it away from your router.

Local Network Interface

The ECU can be configured, and its data reviewed, by connecting a computer to the ECU via the Local Area Network (LAN), or by connecting directly to the ECU via its Ethernet port or Wi-Fi hotspot.

Connecting to the ECU via the LAN

1. Make sure both your computer and the ECU are correctly connected to the LAN.
2. Using a standard web browser on your computer, enter the IP Address that is displayed on your ECU into the URL search field.

The ECU's "splash" screen is displayed:

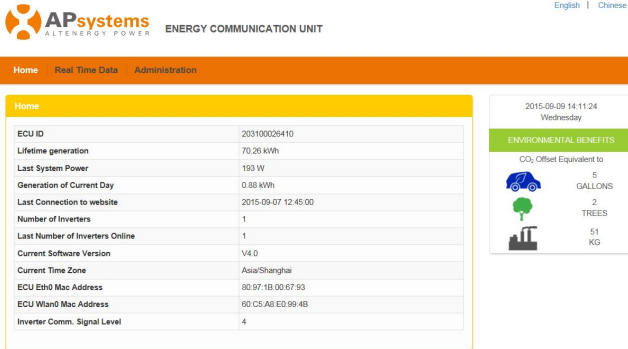

Figure 23

Connecting directly to the ECU via wired LAN

Using a Windows-based PC

1. Connect the computer to the ECU using a CAT5 network cable.
2. Power up the ECU by connecting the power cable.
3. Open the "Network and Sharing Center" in the Control Panel on the PC.
4. Select "Local Area Connection" for "Unidentified Network".
5. Select "Properties" when "Local Area Connection Status" (LAC) window is displayed.
6. Highlight "Internet Protocol Version 4 (TCP/IPv4)" when the "Local Area Connection Properties" window is displayed.
7. Select "Use the Following IP Address" radial button and enter the IP Address and Subnet Mask as listed below. Do not enter anything in the DNS Server address section.

IP Address: 192.168.131.1

Subnet Mask: 255.255.255.0

Local Network Interface

8. Select “OK” on the IPv4 Properties window.
9. Close the LAC Properties window.
10. Close the LAC Status window.
11. Close the Network and Sharing Center.
12. Using a standard web browser on your computer, enter the LAN IP address that is displayed on your ECU into the URL search field.

The ECU’s “splash” screen is displayed.

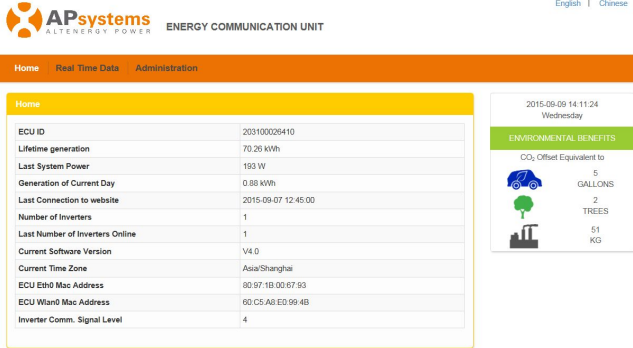

Figure 23

Using an Apple Mac

1. Connect the computer to the ECU using a CAT5 network cable.
2. Power up the ECU by connecting the power cable.
3. Select the Apple icon in the menu bar to access “System Preferences”.
4. Select “Network” in the “Internet & Wireless” section of the System Preferences.
5. Select “Ethernet” on the left side of the Network window.
6. Select “Manually” from the “Configure IPv4” dropdown menu.
7. Enter the following in the appropriate fields:
IP Address: 192.168.131.1
Subnet Mask: 255.255.255.0
8. Leave the “Router” field blank.
9. Select “Apply”.
10. Using a standard web browser on your computer, enter the LAN IP address that is displayed on your ECU into the URL search field.

The ECU’s “splash” screen is displayed:

Local Network Interface

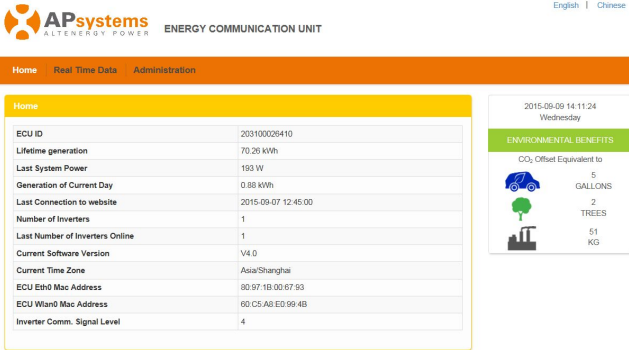

Figure 23

Connecting to the ECU via the Wi-Fi hotspot

1. Turn on the Wi-Fi function on PC.
2. Connect to the ECU's Wi-Fi named with **ECU-WIFI_xxxx** (the "xxxx" refers to the last 4 numbers of the ECU ID), and connect. The first connection has no password.
3. Using a standard web browser on your computer, enter the wireless IP address that is displayed on your ECU into the URL search field.

The ECU's "splash" screen is displayed.

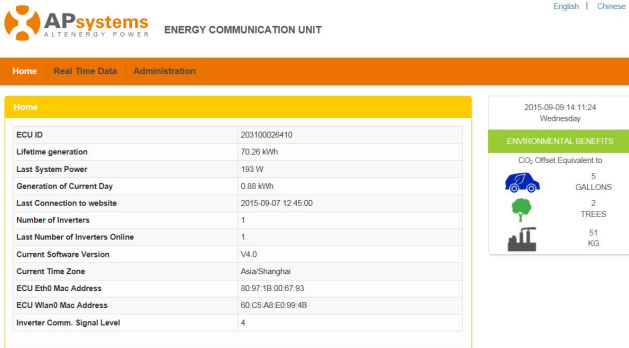

Figure 23

Local Network Interface

Home Screen

Select “Home” at the top of the page.
The Home Page is displayed.

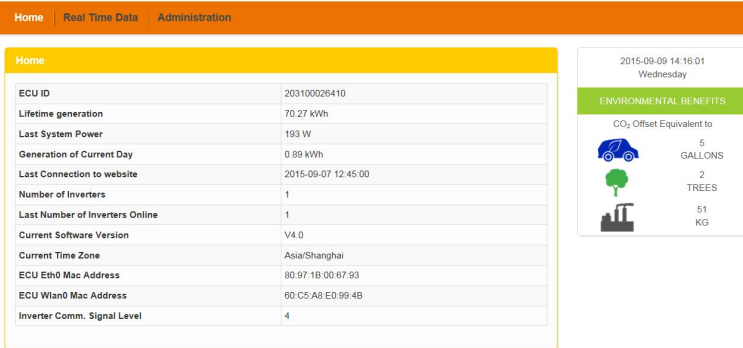

Figure 24

| | |
|----------------------------------|--|
| ECU ID: | This is a unique number that identifies this specific ECU. |
| Lifetime Generation: | Amount of power this system has generated during its lifetime. |
| Last System Power: | Amount of power the system was generating during its last polling cycle. |
| Generation of Current Day: | Amount of power that has been generated during the most current day. |
| Last connection to Website: | The last time the ECU checked into the central APsystems EMA database. |
| Number of Inverters: | Number of inverters that have programmed into the ECU. |
| Last Number of Inverters Online: | Number of inverters that are checking in with the ECU. |
| Current Software Version: | Current version of the firmware. |
| Current Timezone: | Time zone that has been programmed into the ECU. |
| ECU Eth0 Mac Address | Address of ECU's LAN. |
| ECU Wlan0 Mac Address | Address of the ECU's internal WLAN. |
| Inverter Comm. Signal Level | The communication strength between inverters and ECU. The range is 1-5, the higher the better. |

Local Network Interface

Real-time Data Screen

a) Real Time Data

To view the real-time system operation data statistics for your solar array, click “Real Time Data” from the ECU home screen to navigate to the real-time data screen.

The Real Time Data screen is displayed.

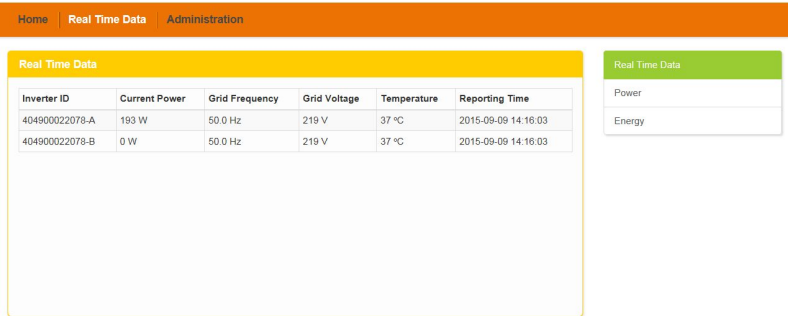

Figure 25

b) Trend of system power

To view the system power of any period, click "Power" at the real-time data page.

The Trend of system power screen is displayed.

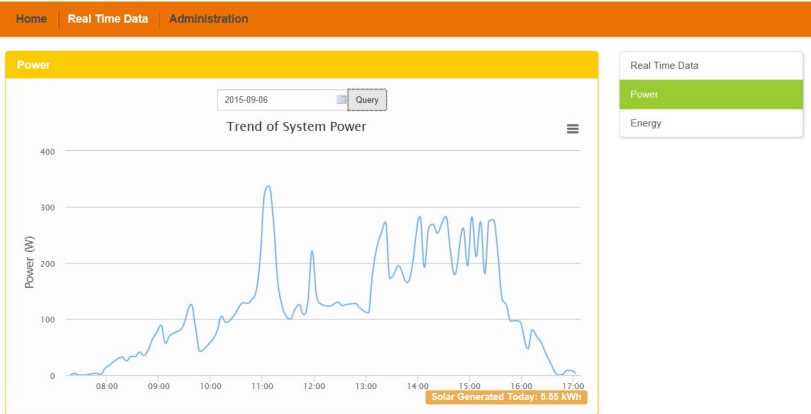

Figure 26

c) Power generation statistics

Press “Energy” at the real-time data page to view the system power generation of your solar array.

Local Network Interface

The Power generation statistics screen is displayed.
Performance data for the current week:



Figure 27

Performance data for the current month.



Figure 28

Performance data for the current year.

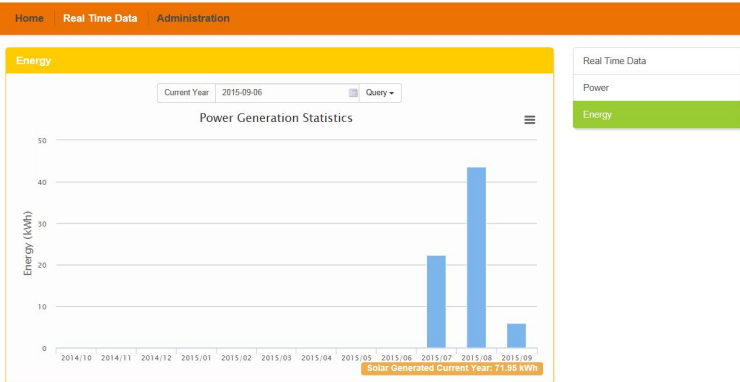

Figure 29

Local Network Interface

Administration Screen

a) Managing Inverter IDs

The inverter IDs must be programmed into the ECU for the ECU to recognize the inverters. The ECU will NOT auto-sense the inverters.

Initial Programming of the ECU with the Inverter IDs.

NOTE: The “Enter Inverter ID” window field will be blank if you have not yet entered any of the inverter IDs.



- 1) Select “Administration” at the top of the page.

The ID Management page is displayed.

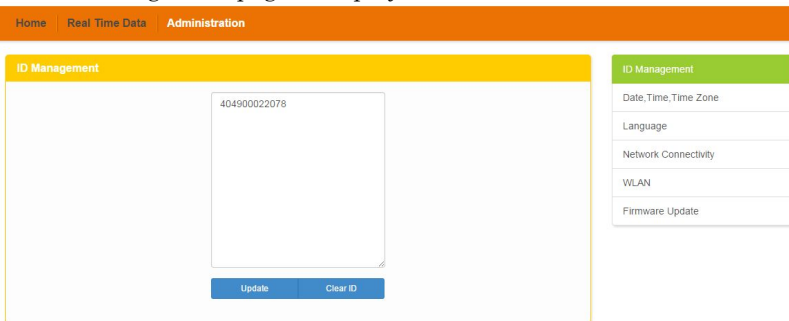

Figure 30

If you manually input the inverter IDs -

- 2) Enter each 12-digit inverter ID.
- 3) Once all the ID have been entered, press “Update”.
“ID updated successfully!” will displayed after a few seconds.

If using the Scanning Gun to input the inverter IDs -

- 2) Copy the scanned IDs into the ID Management box
- 3) Press “Update”. The message “ID updated successfully !” will be displayed after few seconds.

Adding Additional Inverter IDs

If the number of inverter ID displayed on the page is less than the actual number of inverters installed:

- 1) Select “Administration” at the top of the page.

The ID Management page with the existing inverter IDs is displayed.

Local Network Interface

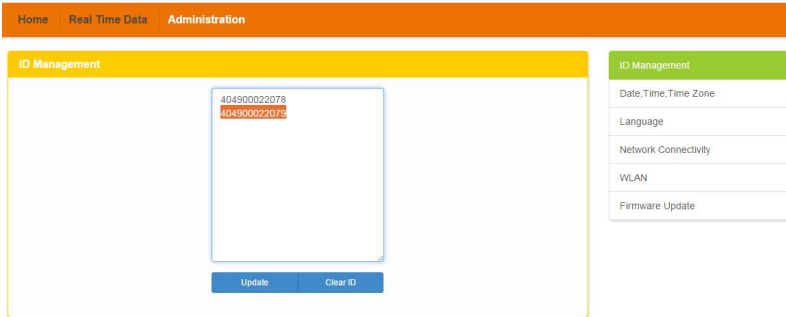

Figure 31

- 3) Scroll down to the end of the existing list.
- 4) Enter the new ID.
- 5) Press “Update”. The “ID updated successfully!” message will be displayed after few seconds.

Deleting an Existing Inverter ID

If the number of inverter IDs displayed on the page is more than the actual number of inverters installed:

- 1) Select “Administration” at the top of the page.

The ID Management page with the existing inverter IDs is displayed.

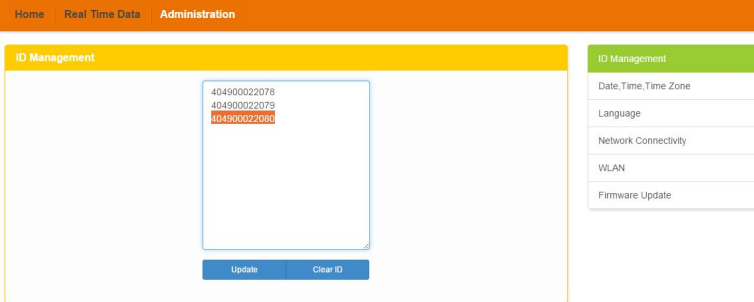

Figure 32

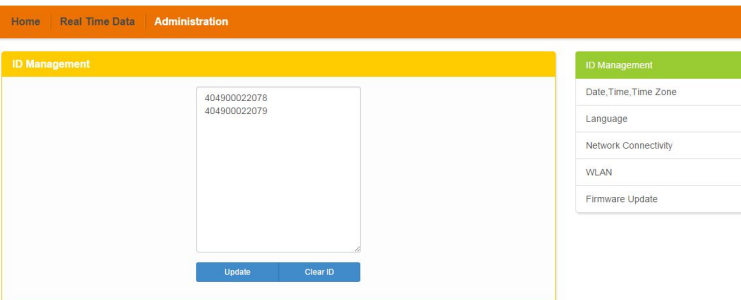

Figure 33

Local Network Interface

- 3) Highlight the IDs to be deleted from the list.
- 4) Press “Update”. The “ID updated successfully!” message will be displayed after few seconds.

Modify an Existing Inverter ID

If the inverter ID displayed on the page does not match the actual inverters ID installed, modify the wrong inverters ID from “Input Inverter ID” section, then click “Update”. The message “ID updated successfully!” will be displayed after few seconds.

The ID Management page with the existing inverter IDs is displayed:

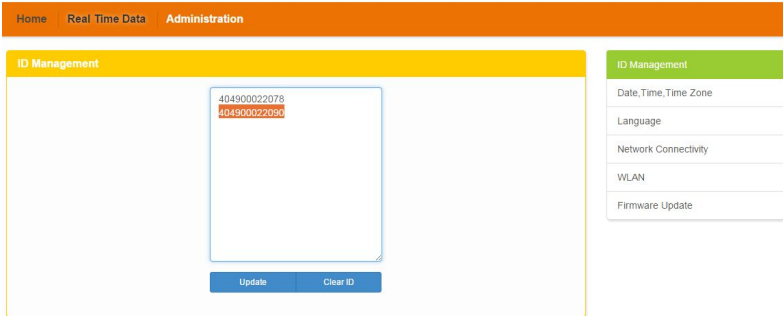

Figure 34

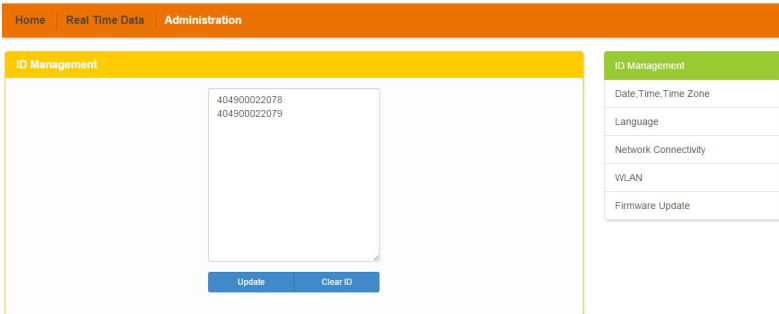

Figure 35

Local Network Interface

Clearing inverter IDs

Pressing “Clear ID” deletes ALL of the inverter IDs from the list.

The ID Management page with the existing inverter IDs is displayed.

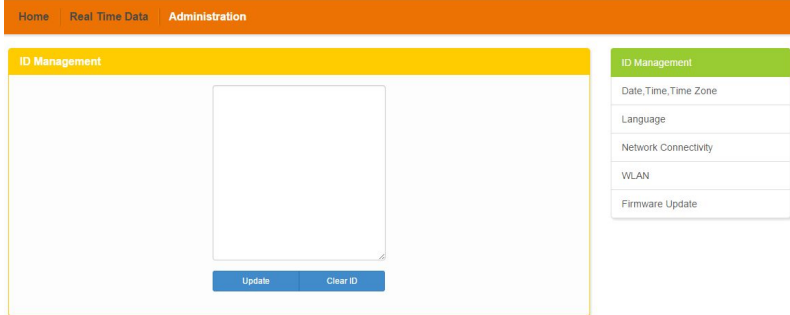

Figure 36

NOTE: Combine the above two steps when swapping out an inverter. Add the new inverter, and Delete the old one. Remember to follow up with the same process on the APsystems EMA because the ECU and EMA need to be in sync with each other.



b) Changing the Date, Time Zone

It is critical for accurate power production reporting that the ECU is programmed with the correct date, time, and time zone.

- 1) Select “Administration” at the top of the page.
- 2) Select “Date, Time, Timezone”.

The Date, Time, Time Zone page is displayed:

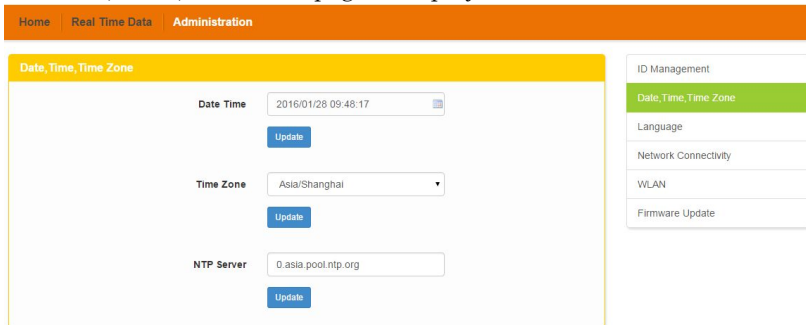

Figure 37

- 3) Adjust the correct date in the “Date Time” field
- 4) Select the correct time zone from the Time Zone pull down.

Local Network Interface

NOTE: You can skip step 3 by selecting the correct time zone. Selecting the correct time zone automatically updates both the date and current time.



c) Changing the Language

Users can switch language between English and Chinese.

- 1) Select “Administration” at the top of the page.
- 2) Select “Language”.

The Language management page is displayed:

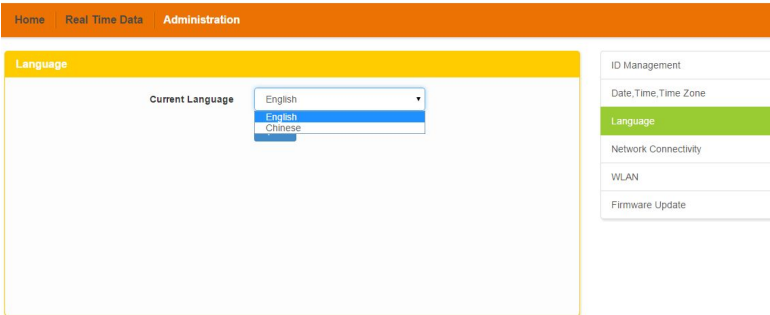

Figure 38

- 3) Select the language from the Current Language pull down.
- 4) Press “Update”.

d) Managing the Network Connection

The default network connection setting for the ECU is “DHCP,” which allows the ECU to automatically establish a connection assignment from the router. The ECU can be assigned a static IP Address if the network design requires it.

- 1) Select “Administration” at the top of the page.
- 2) Select “Network Connectivity”.

The Network Connectivity page is displayed:

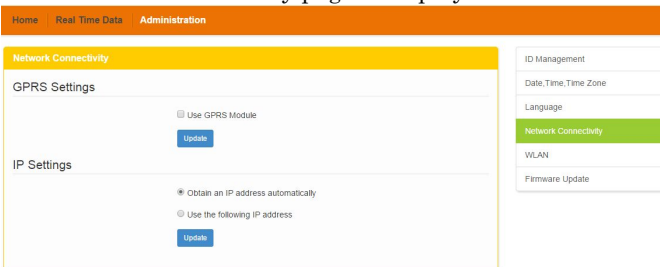

Figure 39

Local Network Interface

- 3) Select “Obtain an IP address automatically”.
- 4) Press “Update”.

e) Managing the WLAN connection

The ECU can both work in two modes: WLAN and Local Wireless Access. In WLAN mode, the ECU can connect to a router by Wi-Fi. In Local Wireless Access mode, user’s phone or PC can connect to ECU to access local web.

WLAN mode

- 1) Select “Administration” at the top of the page.
- 2) Select “WLAN”, and click “WLAN” tab.



Figure 40

- 3) The ECU will display the available networks.
Select the button next to the available network that you wish to access SSID, and a password entry field will be displayed below the network name. Enter the password into the password entry field, then click “Connect”.

The WLAN Connectivity page is displayed.

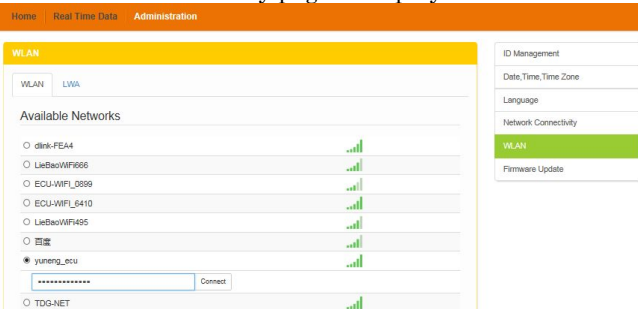

Figure 41

- 4) If ECU has connected to the router, it will display the SSID and IP address. Now you can connect by PC or phone to the router. Enter the ECU’s IP (e.g., 192.168.1.112) into the browser to access the local web.

Local Network Interface

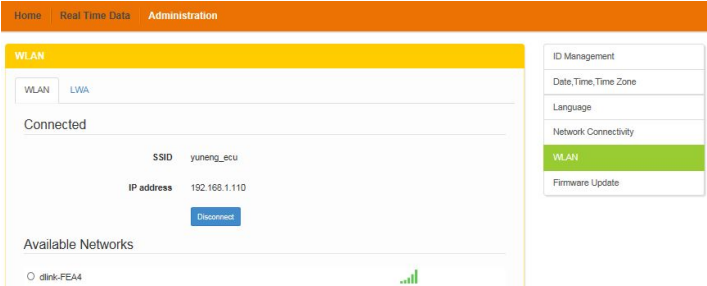

Figure 42

Local Wireless Access mode

- 1) Scan the ECU's SSID on PC and phone, and connect to ECU. Enter the ECU's IP 172.30.1.1(The IP is fixed) into browser to access the local web.
- 2) On the page, you can modify SSID, Channel, Safe Type and Password. If you don't select the Safe Type, the Password is hidden.

The Local Wireless Access page is displayed.

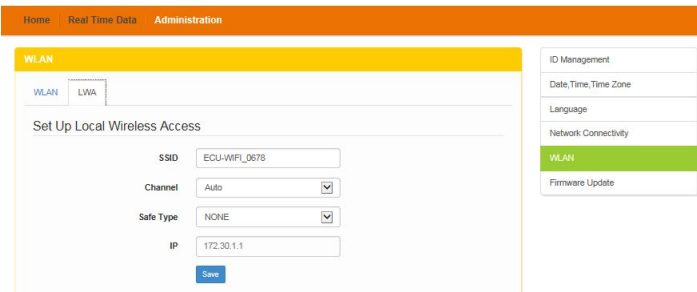

Figure 43

f) Firmware Update

Select the ECU upgrade package, and click OK to upgrade ECU firmware. The upgrade package can be downloaded at www.APsystems.com.

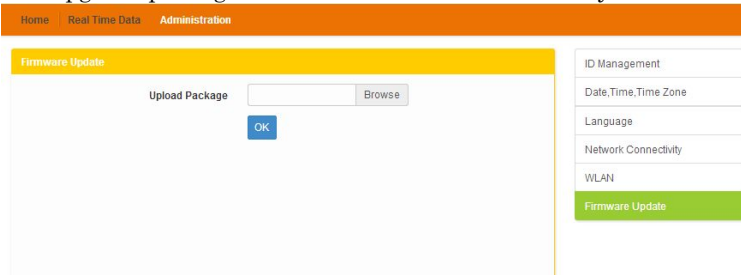

Figure 44

Remote ECU Management (EMA)

The ECU has been designed with remote connect functionality. You can access this remote functionality through the APsystems Energy Monitoring & Analysis (EMA) website, using your installer login credentials. Changes made remotely through the EMA do not take effect until the ECU's next reporting cycle.

The ECU must first be installed with verified Power Line Communication (PLC) and Internet connectivity.

The ECU remote functionality allows you to do the following:

- Set Time Zones
- Manage Inverter IDs

There are additional ECU functions available but the instructions are not outlined in this document. If you need to access one of the following features, please contact APsystems Technical Support:

- Change system parameters
- Turn the inverters ON and OFF
- Reset GFDI
- Reset Power Settings

NOTE: This section of the documentation assumes you have a working knowledge of the APsystems EMA.



- 1) Log onto your APsystems EMA account. Your Customer List within the Installer Portal is displayed.
- 2) Select the customer's ECU you want to manage and click on the pencil icon in the "Change ECU Status column".

The screenshot shows the APsystems Installer Portal interface. At the top, there is a navigation bar with the APsystems logo and the text "INSTALLER PORTAL ENERGY MONITORING & ANALYSIS". Below the logo are four icons: a customer icon, a registration icon, a FAQ icon, and a settings/sign out icon. The main content area is titled "INSTALLER" and shows a "Customer List" table. The table has columns for ID, User Account, ECU ID, User Name, Country, State, City, System Size(KW), Register Date, Change ECU Status, and Delete. There are four rows of data in the table, each with a pencil icon in the "Change ECU Status" column. Below the table, it says "4 results found, displaying 1 to 4".

| ID | User Account | ECU ID | User Name | Country | State | City | System Size(KW) | Register Date | Change ECU Status | Delete |
|----|--------------|--------------|--------------|---------------|------------|---------------|-----------------|---------------|-------------------|--------|
| 1 | PVUSA | 203000006666 | Steve Coonan | United States | California | Davis | | 2014-02-07 | | |
| 2 | APSAbackshop | 203000006700 | John Doerr | United States | Washington | Poulsbo | | 2014-01-21 | | |
| 3 | NDrouin | 203000006557 | Nick Drouin | United States | WA | Bellevue | 10 | 2013-12-20 | | |
| 4 | MLanson | 203000006590 | Mike Larson | United States | Washington | Mercer Island | 4.3 | 2013-10-24 | | |

Figure 45

Remote ECU Management (EMA)

ECU Configuration/ECU Status Page

The ECU SETTING page is your entry point into managing ECUs remotely.

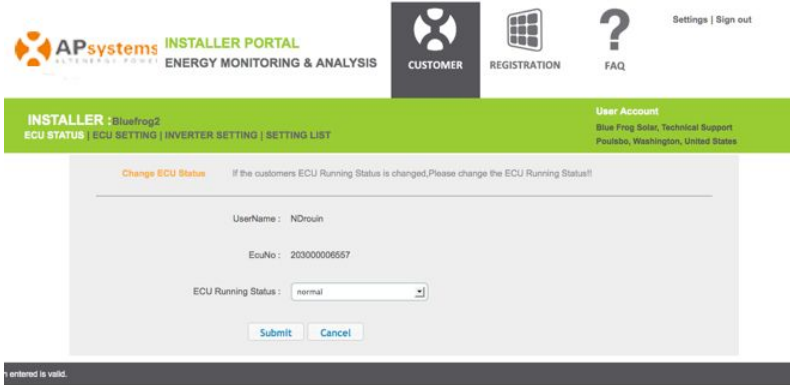

Figure 46

The ECU SETTING tab allows you to:

Set Time Zones

- The ECU time zone can be set or adjusted remotely through the ECU setting tab. If the time zone is not properly set, the solar production data will not post properly on the EMA site.

Load Inverter IDs

- Once the ECU has been installed you can access the ECU remotely to add the inverter IDs. Until the inverter IDs are loaded, the ECU will not be able to collect data from the inverters.

Update Inverter ID list

- If an inverter(s) is added or swapped for a new unit, then the ECU's programmed list of inverters will need to be updated.

Remote ECU Management (EMA)

Setting the ECU Time Zone

- 1) Select the “ECU SETTING” tab.

The ECU Configuration page is displayed.

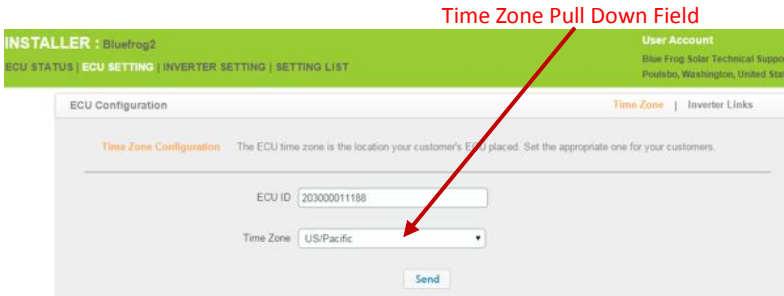

Figure 47

- 2) Using the “Time Zone” pull down field, select the appropriate time zone.
- 3) Press “Send”.

Managing Inverter IDs and Updating the Inverter ID List

- 1) Select the “ECU SETTING” tab.
- 2) Select the “Inverter Links” tab.

The Inverter Links Configuration page is displayed

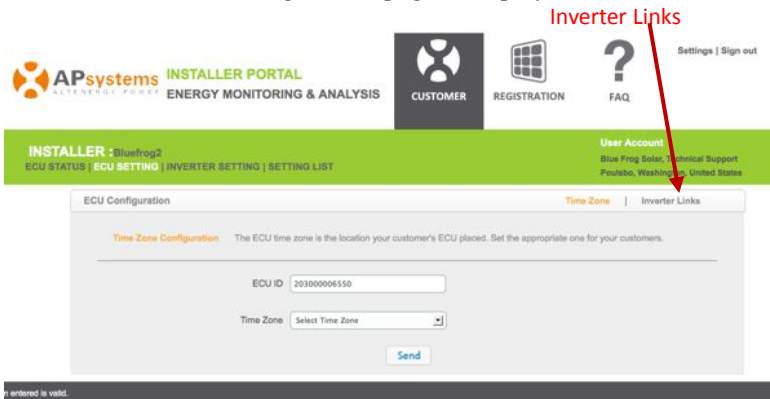

Figure 48

Remote ECU Management (EMA)

Operation Selection (Add or Delete)

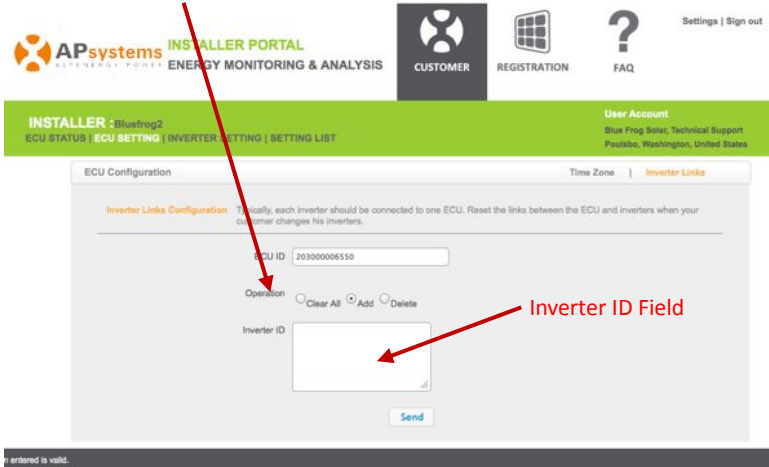

Figure 49

Adding Complete List of Inverter IDs for a Newly Installed System

There are three different approaches to add the inverter IDs:

Option 1: Manually input the inverter IDs -

- 1) Select “Add” in Operation Selection.
- 2) Enter all of the inverter IDs into the Inverter ID Field (one per line).
- 3) Press “Send”.

Option 2: Using the Scanning Gun to scan the inverter IDs -

- 1) Select “Add” in Operation Selection.
- 2) Copy the scanned IDs into the Inverter ID Field (one per line).
- 3) Press “Send”.

Option 3: Scan the inverter IDs by mobile phone -

- 1) Log onto EMA App.
- 2) Scan the inverter IDs.

Delete IDs from Inverter List

- 1) Select “Delete” in Operation Selection.
- 2) Enter all of the inverters to be removed from the Inverter ID Field.
- 3) Press “Send”.

Technical Data

| | |
|--------------------------------|---|
| Model: ECU-3 | |
| Version: 4 | |
| Communication Interface | |
| Integrated Wi-Fi | 802.11g/n |
| Ethernet | 10/100M Auto-sensing, Auto-negotiation |
| USB interface | Standard |
| RS232 | Standard |
| Power Requirements | |
| AC Outlet | 110~240 VAC, 50~60 Hz |
| Power Consumption | 2.5 W |
| Mechanical Data | |
| Dimensions (W×H×D) | 182mm×113mm×42mm (7.1"×4.4"×1.6") |
| Weight | 380g (0.83lbs) |
| Ambient Temperature Range | -20°C to +65°C (-4°F to 149°F) |
| Cooling | Nature Convection; No Fans |
| Enclosure Environmental Rating | Indoor - NEMA 1(IP30) |
| Features | |
| Compliance | IEC 60950-1, EN60950-1, IEC 60529, EN 60529, ANSI/UL 60950-1, CAN/CSA C22.2 No.60950-1, UL50E, FCC part 15, EN61000-6-1,EN61000-6-3, ICES-003, AS NZS 60950-1, GB/T17799 |

Specifications subject to change without notice.

Please ensure you are using the most recent update found at www.APsystems.com.

This device complies with part 15 of the FCC Rules. Operation is subject to the following two conditions: (1) This device may not cause harmful interference, and (2) this device must accept any interference received, including interference that may cause undesired operation.

This Class B digital apparatus complies with Canadian ICES-003.

:: WEEE (for Europe)



Disposal of your old appliance

1. When this crossed-out wheeled bin symbol is attached to a product, it means the product is covered by the European Directive 2002/96/EC.
2. All electrical and electronic products should be disposed of separately from the municipal waste stream via designated collection facilities appointed by the government or the local authorities.
3. The correct disposal of your old appliance will help prevent potential negative consequences for the environment and human health.
4. For more detailed information about disposal of your old appliance, please contact your city office, waste disposal service or the shop where you purchased the product.

Contact Information

ALTENERGY POWER SYSTEM Inc.

www.APsystems.com

APsystems Jiaying China

No. 1, Yatai Road, Nanhu District, Jiaying, Zhejiang

Tel: +86 573 8398 6967

Mail: info@altenergy-power.com

APsystems Shanghai China

B403 No. 188, Zhangyang Road, Pudong, Shanghai

Tel: +86 021 3392 8205

Mail: info@altenergy-power.com

APsystems Australia

Suite 502, 8 Help Street, Chatswood NSW 2067 Australia

Tel: +61 (0)2 8034 6587

Mail: info@altenergy-power.com

APsystems America

600 Ericksen Ave NE, Suite 200 Seattle, WA 98110

Tel: 844-666-7035

Mail: info@APsystems.com

APsystems Europe

Cypresbaan 7,2908LT, Capelle aan den IJssel, The Netherlands

Tel: +0031-10-2582670

Mail: info@altenergy-power.com