

Ca. 3 à 4 mm speling houden en  
afdichten met compriband 15 mm

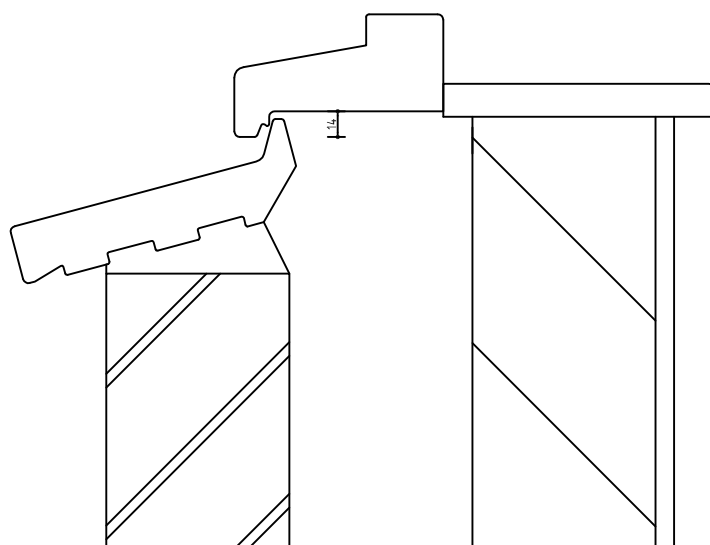

## Renovatie detail 1A

Renovatie stijlen en bovendorpel 9 mm, onderdorpel 14 mm.